



UM90024

4 kW analogue bridgeless totem-pole PFC evaluation board

Rev. 1.0 — 21 November 2023

user manual

Document information

Information	Content
Keywords	GaN FET, PFC, evaluation board, circuit design, PCB layout
Abstract	The analogue totem-pole PFC evaluation board is a bridgeless totem-pole Power-factor-Correction (PFC) circuit.

1. EVALUATION BOARD TERMS OF USE

The use of the Evaluation Board is subject to the Evaluation Board Terms of Use, which you can find [here](#). By using this Evaluation Board, you accept these terms.

2. High Voltage Safety Precautions

Read all safety precautions before use!

Please note that this document covers only the 4kW analogue bridgeless totem-pole PFC evaluation board and its functions. For additional information, please refer to the Product Specification

To ensure safe operation, please carefully read all precautions before handling the evaluation board. Depending on the configuration of the board and voltages used, potentially lethal voltages may be generated. Therefore, please make sure to read and observe all safety precautions described below.

Before Use:

It is recommended that ALL operation and testing of the evaluation board is performed with the board enclosed within a non-conductive enclosure that prevents the High Voltage supply to be switched whilst open and accessible; see [Fig. 1](#).

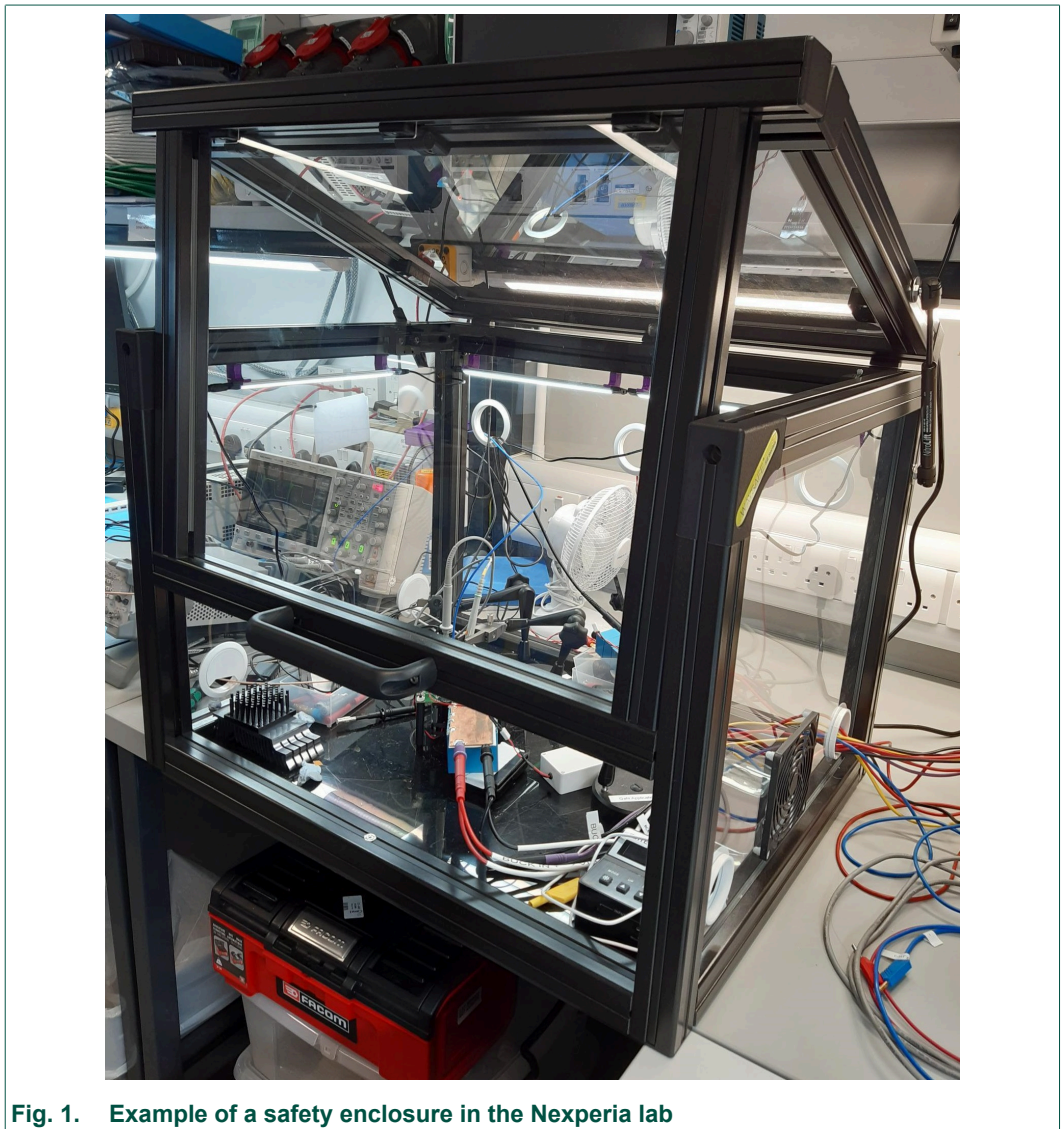

Fig. 1. Example of a safety enclosure in the Nexperia lab

4 kW analogue bridgeless totem-pole PFC evaluation board

All probes should be position before turning on the High Voltage and should be held in place using a suitable probe positioner e.g. PMK MSA100; see [Fig. 2](#).



Fig. 2. Example of a probe positioner

Always use an oscilloscope with protective earth connected.

When probing High Voltage, ensure that the probes have the correct voltage rating / limit.

Ensure that all scope probes are compensated and de-skewed before use, refer to your oscilloscope or probe manual for instructions on how to do this.

If possible, have a visual indicator of High Voltage located close to the evaluation board (LED bar graph or voltmeter) To show when the Bus Voltage (V_{bus}) and Outputs are at dangerous levels.

Verify that none of the parts or components are damaged or missing.

Check that there are no conductive foreign objects on the board.

If any soldering or modifications are made or carried out, then please ensure that this is done carefully so that solder splashes and debris are not created. Clean the board with Iso-propyl-alcohol and allow it to dry.

Ensure that there is no condensation or moisture droplets on the circuit board, all testing should be carried out within a dry environment without excessive humidity.

If used under conditions beyond the rated voltage and current specification, this may cause defects, failure and or permanent damage.

NEVER handle the evaluation board during operation under ANY circumstances

After use the Nexperia Evaluation Board contains components which may store high voltage and will take time to discharge. Carefully probe the evaluation board once the power has been removed to check that all capacitors have been discharged. You must do this without touching the board except for the multimeter probes that are being used to check.

This evaluation board is intended for use only in High Voltage Lab environments and should be handled only by qualified personnel familiar with all safety and operating procedures. We recommend carrying out operation and testing in a safe environment that includes restricted access only to trained personnel, the use of High Voltage signage at all entrances, safety interlocks and emergency stops and HV insulated flooring.

It should be noted that this evaluation board is intended to be used ONLY for evaluation purposes and should not be used by consumers or designed into consumer equipment in its current form.

3. Introduction

The Nexperia Analogue Totem-Pole PFC evaluation board implements a bridgeless totem-pole Power-Factor-Correction (PFC) circuit, using Nexperia power GaN FETs. By using a diode-free power GaN FET bridge with low reverse-recovery charge, very-high-efficiency single-phase AC-DC conversion is realized. In this circuit, the performance and efficiency improvement are achieved by use of GaN FETs in both the fast-switching and slow-switching legs of the circuit. The evaluation board is shown in [Fig. 3](#) and [Fig. 4](#).

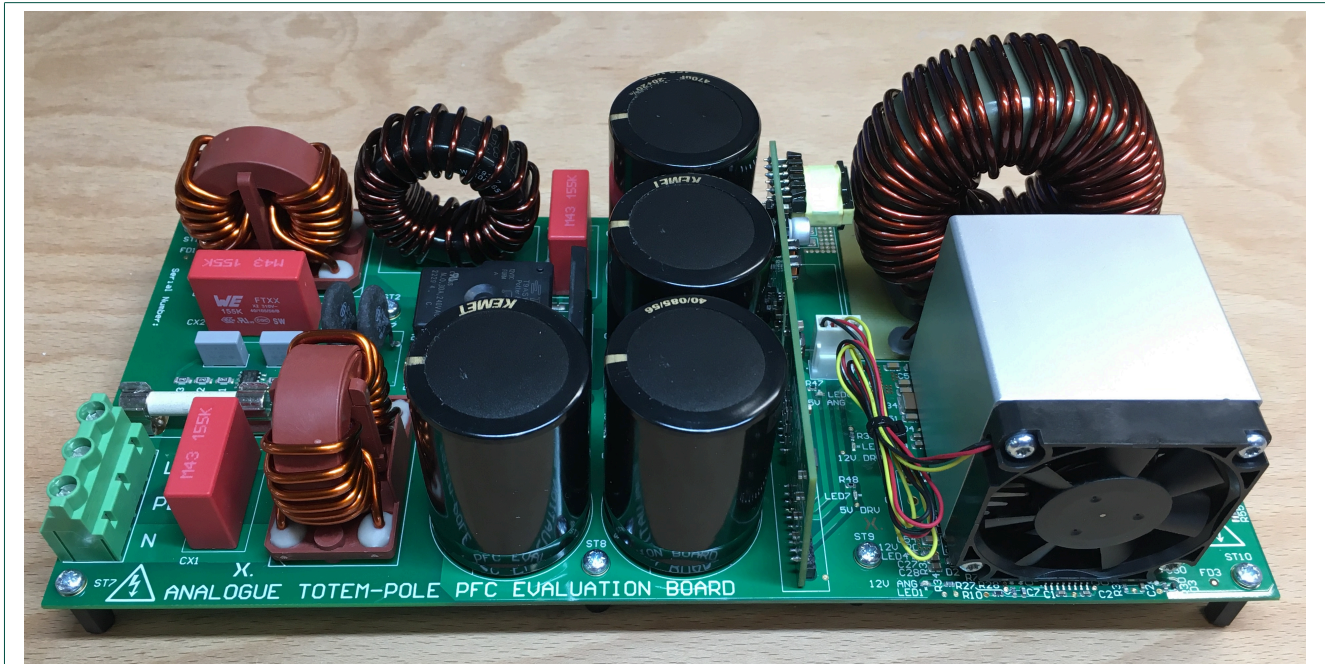

Fig. 3. 4 kW analogue totem-pole PFC evaluation board; top view with control card and heatsink fitted

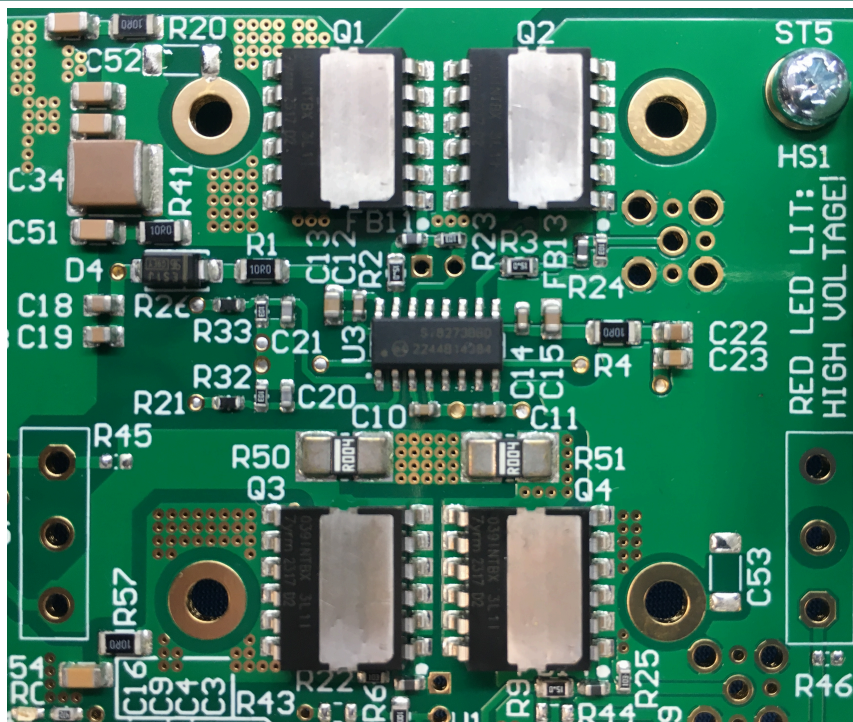

Fig. 4. 4 kW analogue totem-pole PFC evaluation board; top view of GaN FETs (heatsink removed)

3.1. Warnings

This demo board is intended to demonstrate GaN FET technology. While it provides the main features of a totem-pole PFC, it is not intended to be a finished product and does not have all the protection features found in commercial power supplies. Along with this explanation go a few warnings which should be kept in mind:

1. An isolated AC source should be used for the input.
2. Use either a passive resistive load or an electronic load set to resistance mode: 360 W to 2000 W lowline, 360 W to 4000 W highline.
3. The demo board is not fully tested at large load steps. **DO NOT** apply a very large step in the load (>1000 W) when it is running.
4. **DO NOT** manually probe the waveforms when the demo is running. Set up probing before powering up the demo board.
5. **DO NOT** touch any part of the demo board when it is running.
6. When plugging the daughterboard into the sockets, make sure that the daughterboard is fully pushed down.
7. It is not recommended to use a passive voltage probe for VDS and VGS measurements while simultaneously using a differential voltage probe for Vin measurements unless the differential probe has very good dv/dt immunity.
8. **BE AWARE** that DC negative and AC neutral are not the same node, and that unless proper caution is taken with instrument grounding, a severe fault condition could be created.

3.2. Quick reference information

Table 1. 4 kW Analogue Totem-pole PFC evaluation board Input/Output specifications

Parameter	Value
Input voltage	85 VAC to 265 VAC; 47 Hz to 63 Hz
Input current	18 A (RMS): (2000 W at 115 VAC; 4000 W at 230 VAC)
Ambient temperature	<50 °C
Output voltage	385 VDC ±5 VDC
PWM frequency	65 kHz

Power dissipation in the GaN FET is limited by the maximum junction temperature. Refer to the [GAN039-650NTB data sheet](#).

4. Circuit description

The bridgeless totem-pole topology is shown in Fig. 5 below. As shown in Fig. 5 (a), two GaN FETs Q1 and Q2 and two diodes D1 and D2 are used for the line rectification, while in Fig. 5 (b), the circuit is modified, and the diodes are replaced by two further GaN FETs Q3 and Q4 to eliminate diode forward voltage drops and improve efficiency.

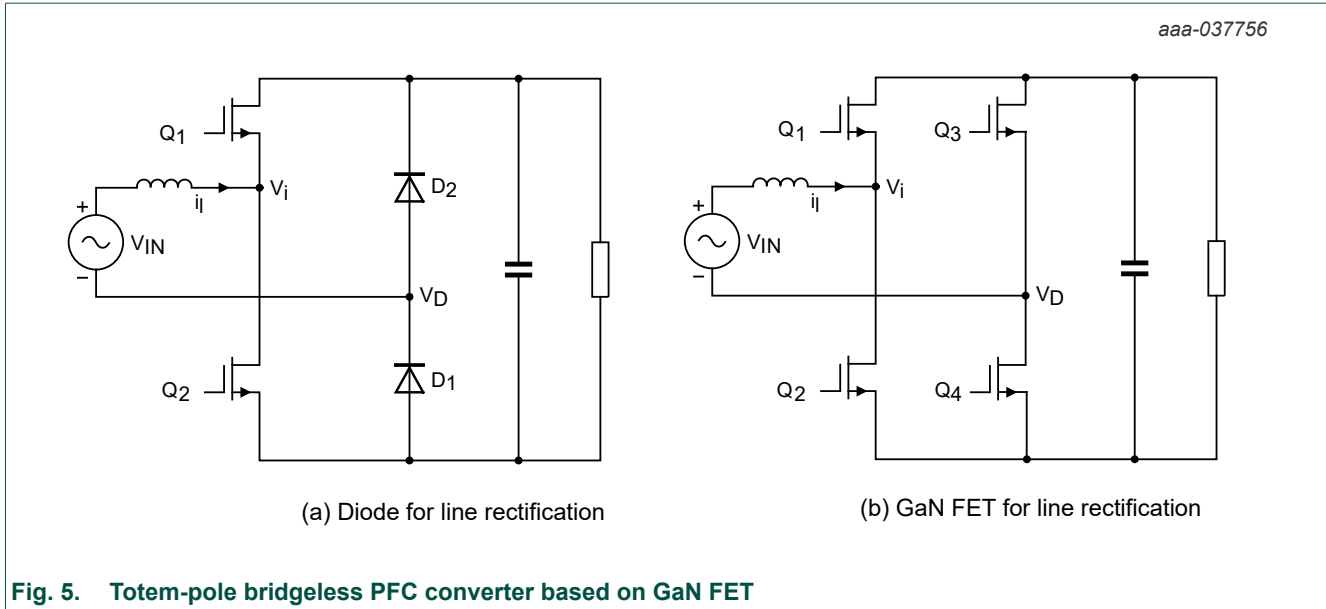

Fig. 5. Totem-pole bridgeless PFC converter based on GaN FET

The large recovery charge (Q_r) of existing silicon MOSFETs makes CCM operation of a silicon totem-pole bridgeless PFC impractical and reduces the total efficiency. Table 2 below compares the Nexperia GAN039-650NTB GaN FET to an equivalent CoolMOS MOSFET.

Table 2. GaN FET and equivalent CoolMOS MOSFET key parameter comparison

Parameter	GAN039-650NTB	IPW65R041CFD
R_{DSon} (max)	39 m Ω	41 m Ω
I_D	60 A	68.5 A
Q_G	26 nC	300 nC
Q_r	187 nC	1.9 μ C

A GaN FET totem-pole PFC in Continuous Conduction Mode (CCM) focusing on minimizing conduction losses was designed. A simplified schematic is shown in Fig. 6 (a). It consists of a pair of fast GaN FET switches (Q1 and Q2) operating at a high pulse width modulation (PWM) frequency and another pair of GaN FET switches (Q3 and Q4) operating at a much lower line frequency (50/60 Hz). The primary current path includes one fast switch and one slow switch only, with no diode drop. The function of Q3 and Q4 is that of a synchronized rectifier as illustrated in Fig. 6 (b) and Fig. 6 (c). During the positive AC cycle, Q4 is on and Q3 is off, forcing the AC neutral line to be tied to the negative terminal of the DC output. The opposite applies for the negative cycle.

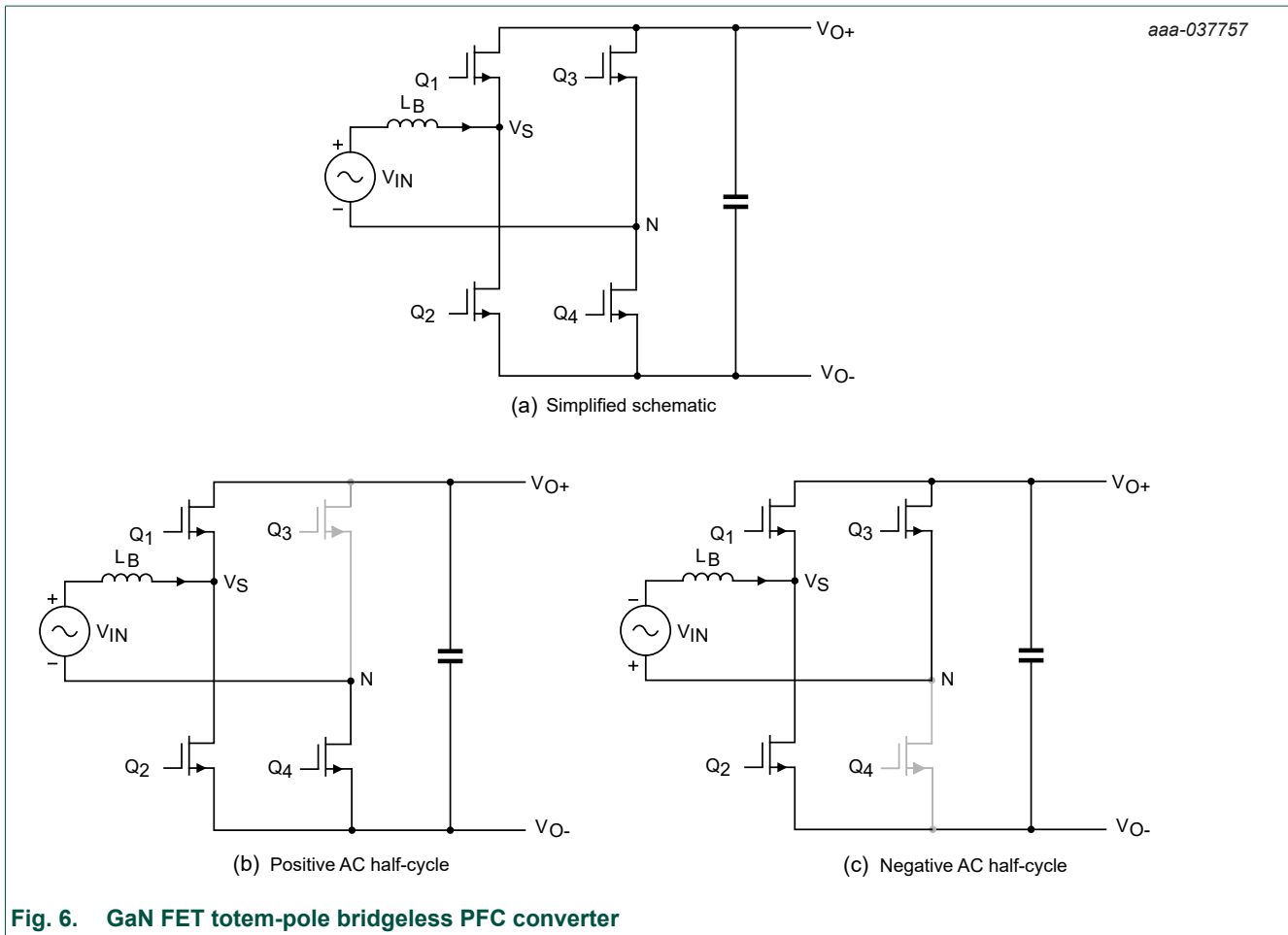

In either AC polarity, the two fast-switching GaN FETs (Q1 and Q2) form a synchronized boost converter with one transistor acting as a master switch to allow energy intake by the boost inductor (L_B) and the other transistor as a slave switch to release energy to the DC output. The roles of the two GaN FET devices interchange when the polarity of the AC input changes; therefore, each transistor must be able to perform both master and slave functions. To avoid shoot through, a dead time is built in between two switching events during which both transistors are momentarily off. To allow CCM operation, the slave transistor must function as a flyback diode for the inductor current to flow during the dead time. The diode current, however, must quickly reduce to zero and transition to the reverse blocking state once the master switch turns on. This is the critical process for a totem pole PFC which previously lead to abnormal spikes, instability and associated high switching losses due to the high Q_r of the body diode in modern high-voltage Si MOSFETs. The low Q_r of the GaN FET switches allows designers to overcome this barrier. As seen in [Fig. 7](#), inductive tests at 400 V bus using the high-side GaN FET as a master switch show healthy voltage waveforms up to inductor current exceeding 35 A. Refer to [Section 7](#) for more details.

With a design goal of 4.4 kW output power in CCM mode at 230 VAC input, the required inductor current is 20 A. This test confirms a successful totem-pole power block with enough current overhead.

One inherent issue in bridgeless totem-pole PFC is the operation mode transition at AC voltage zero-crossing. For instance, when the circuit operation mode changes from positive half-cycle to negative half-cycle at the zero-crossing, the duty ratio of switch Q2 changes abruptly from almost 100% to 0%, and the duty ratio of switch Q1 changes from 0% to 100%. Due to the slow reverse recovery of diodes (or body diode of MOSFET), the voltage V_S cannot jump from ground to VDC instantly; a current spike will be induced. To avoid the problem, a soft-start sequence with a duty ratio ramp is employed for a short period at each AC zero-crossing for better stability. Since the Analogue totem-pole bridgeless PFC is designed to run in CCM, the larger inductance alleviates the current spike issue at zero-crossing.

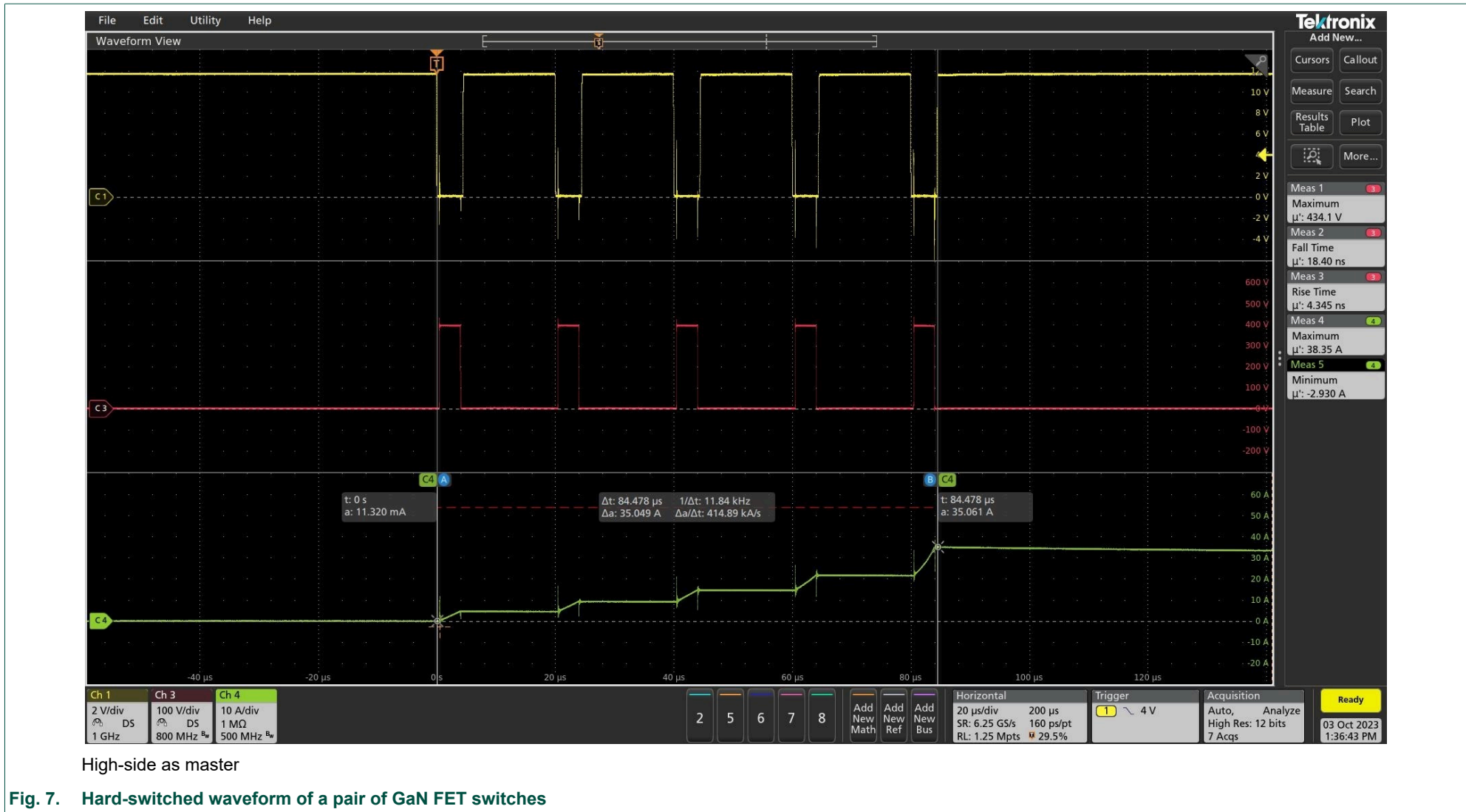

5. Design details

For this evaluation board, the PFC circuit has been implemented on a 4-layer PCB, with 2 oz copper for the outer layers and 1.5 oz copper for the inner layers. GAN039-650NTB devices by Nexperia are used for both the fast and slow switching legs. The inductor is made of a High Flux core with the inductance of 480 μH and a DC resistance of 0.025 Ω , designed to operate at 65 kHz. A simple 4 A rated high/low side driver IC (Si8273) with 0 V and 12 V as the on/off voltage levels directly drives each GaN FET. A TI UCC28180DR controller IC handles the control algorithm.

The voltage and current loop controls are those of a conventional boost PFC converter. The feedback signals are DC output voltage (VDC_OUT), AC input potential (LIVE_IN/POWER_IN) and inductor current (I_SENSE). The input voltage polarity and RMS value are determined from LIVE_IN/POWER_IN. The outer voltage loop output multiplied by $|V_{AC}|$ gives a sinusoidal current reference. The current loop gives the proper duty ratio for the boost circuit. The polarity determines how the PWM signal is distributed to drive Q1 and Q2. A soft-start sequence with a duty ratio ramp is employed for a short period at each AC zero-crossing for better stability.

The circuit schematic, PCB layout and bill of materials for the Analogue bridgeless totem-pole PFC evaluation boards are shown in the next sections.

5.1. Mainboard schematics

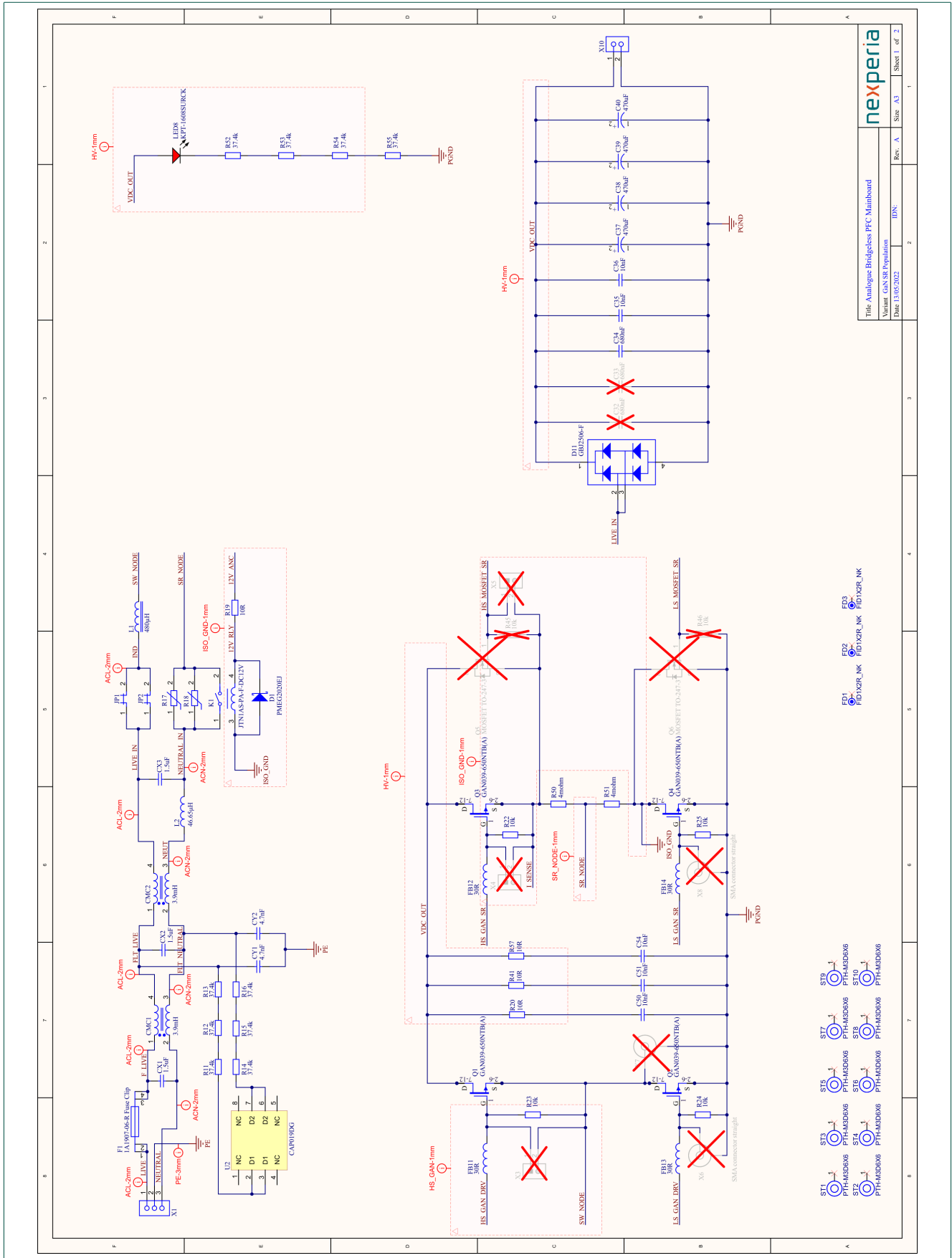

Title Analogue Bridgeless PFC Mainboard		Rev. A	Size A3	Sheet 1 of 2
Version: GAN SR Population		IDN:		
Date: 13/02/2022				

4 kW analogue bridgeless totem-pole PFC evaluation board

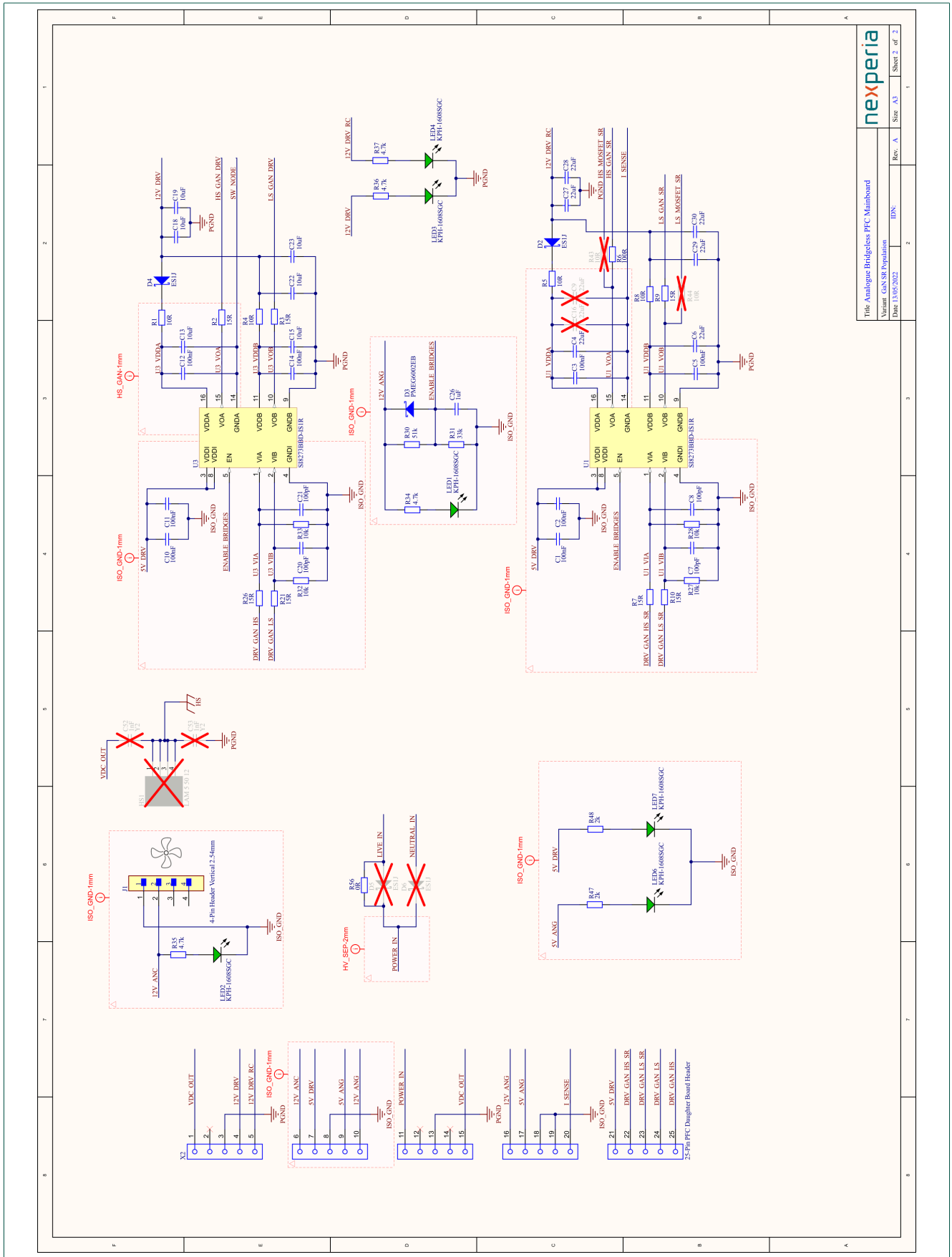

Title: Analogue Bridgeless PFC Mainboard	
Variant: GAN SR Population	
Date: 13/05/2022	IDN:
Rev. A	Sheet 2 of 2

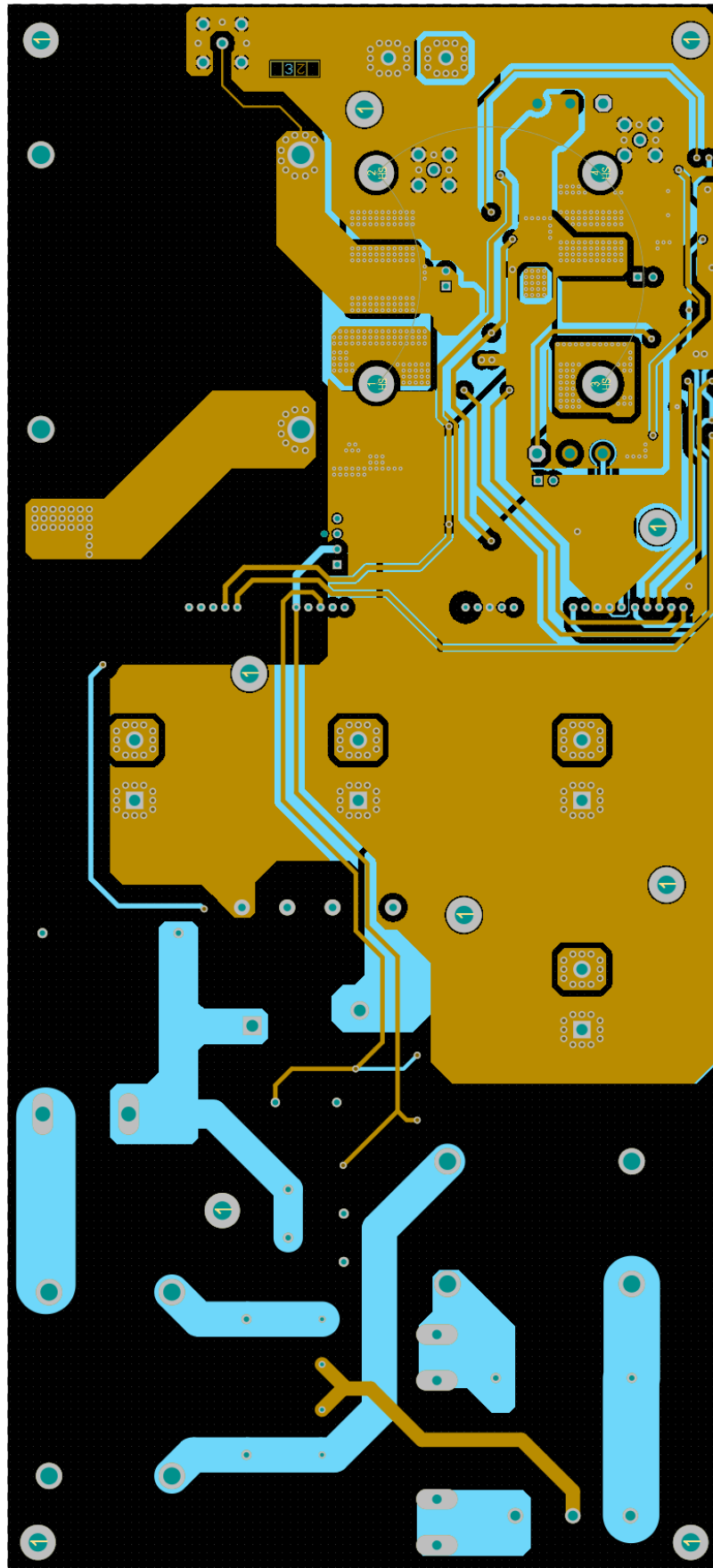
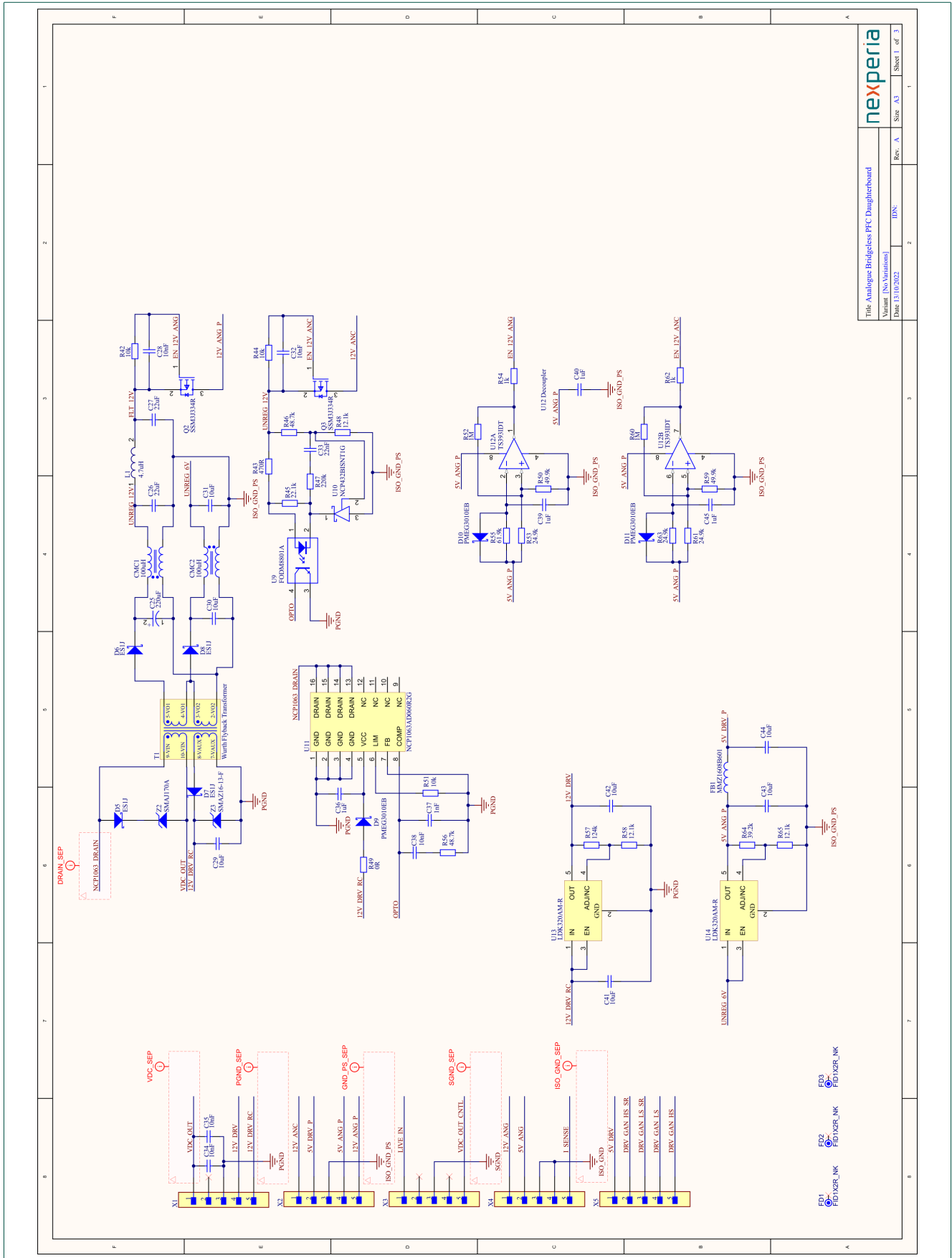
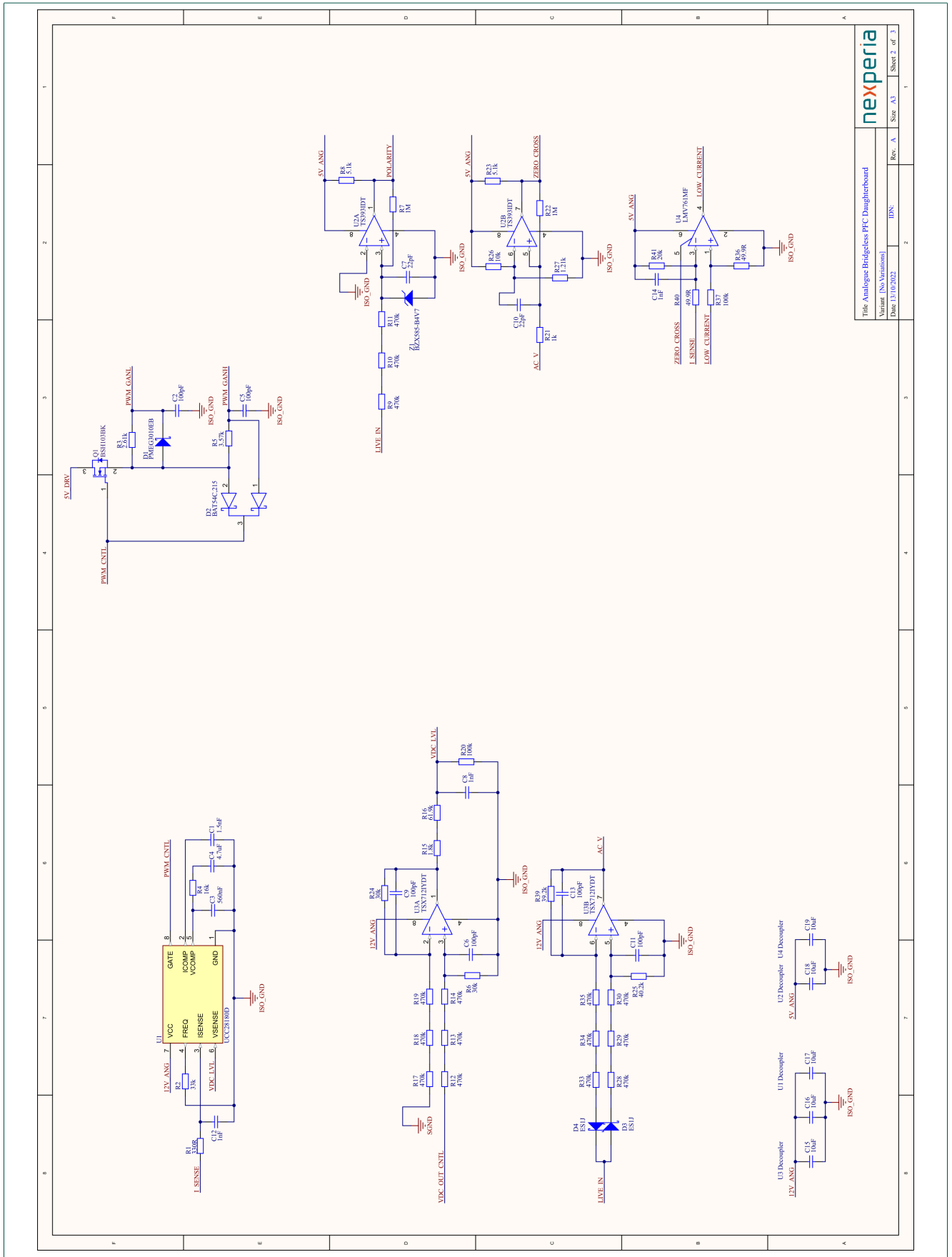

Fig. 10. Mainboard PCB inner layers 2 (ground plane) and 3 (power and ground planes)

5.3. Daughterboard schematics



4 kW analogue bridgeless totem-pole PFC evaluation board



4 kW analogue bridgeless totem-pole PFC evaluation board

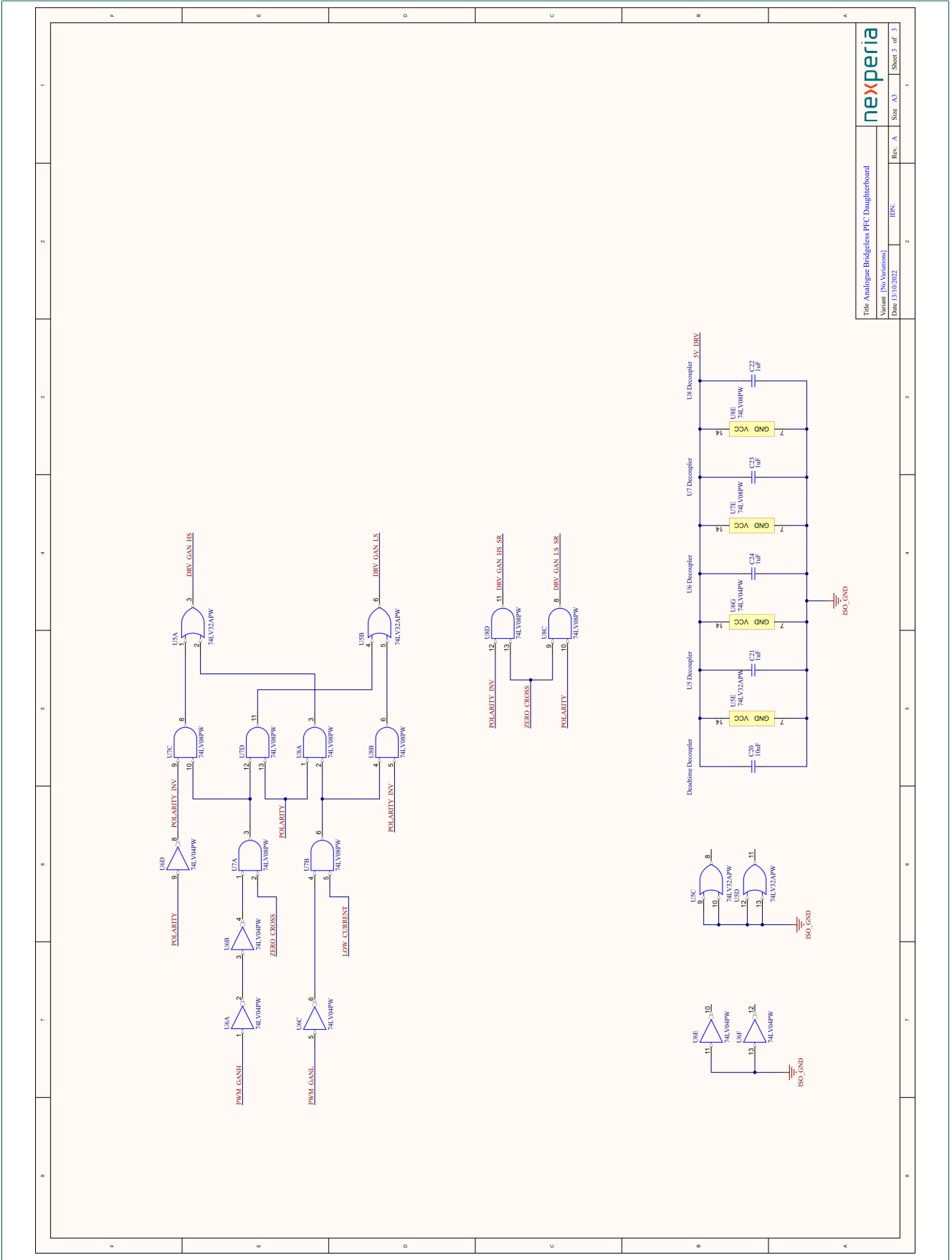

5.4. Daughterboard PCB Layout

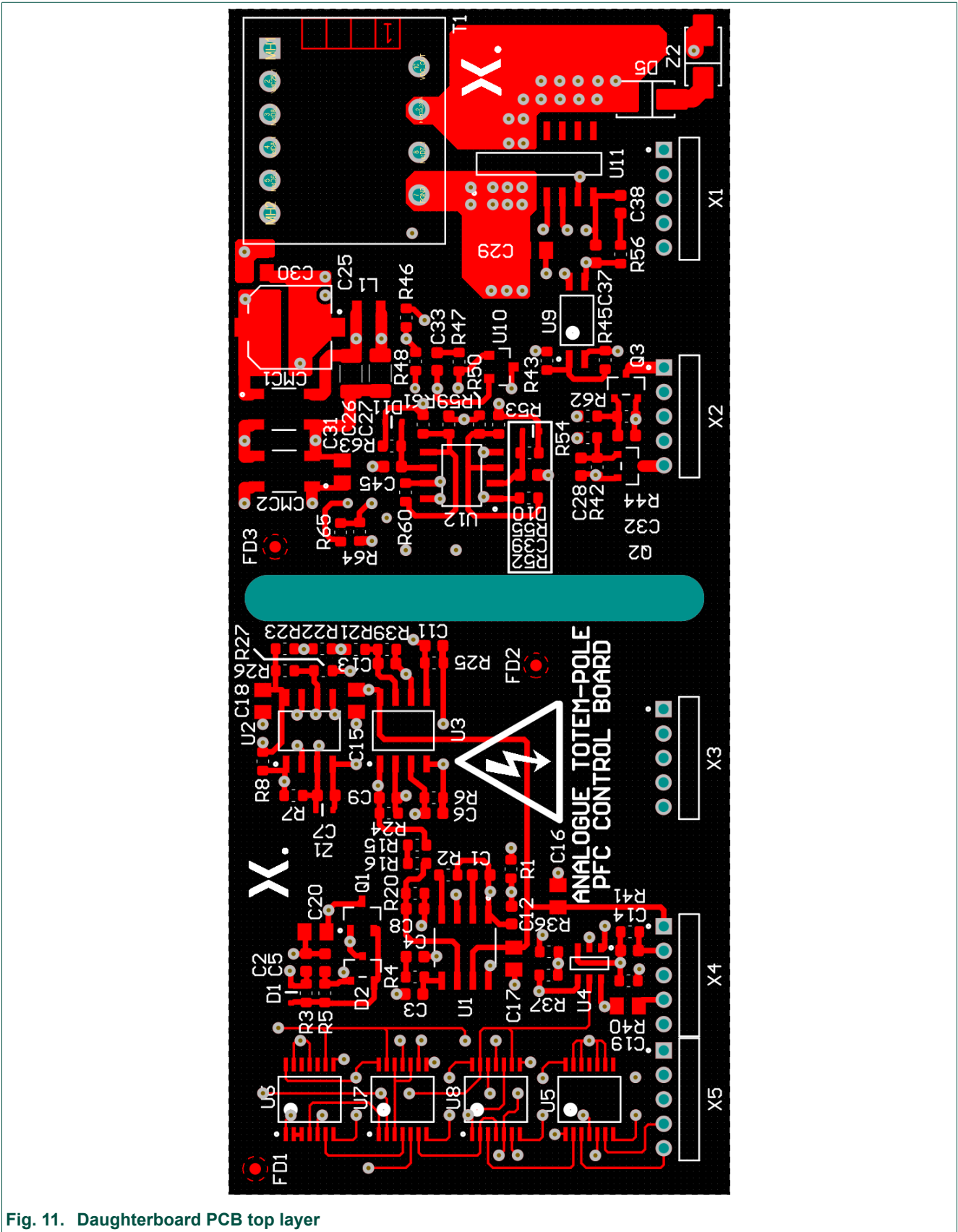

Fig. 11. Daughterboard PCB top layer

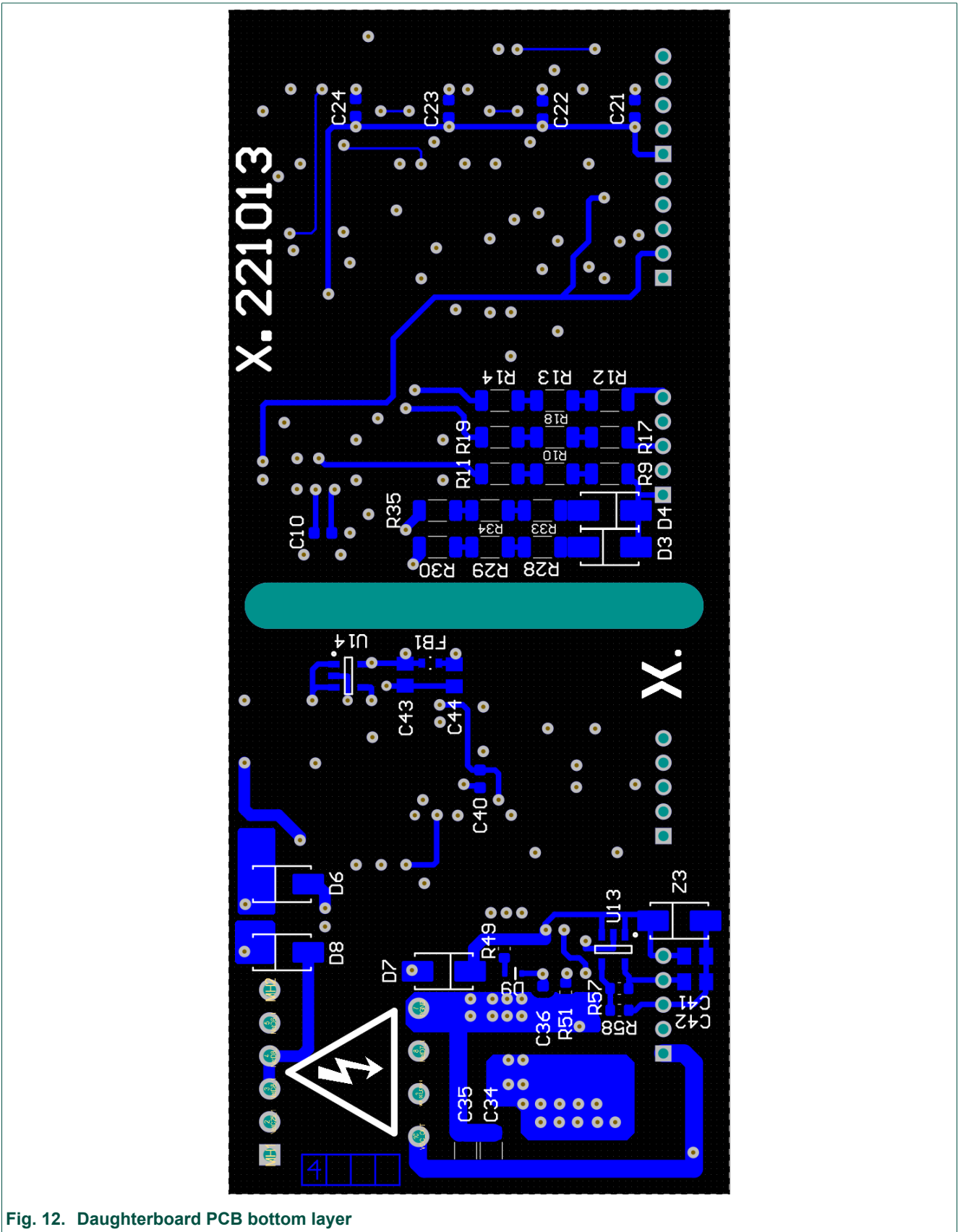

Fig. 12. Daughterboard PCB bottom layer

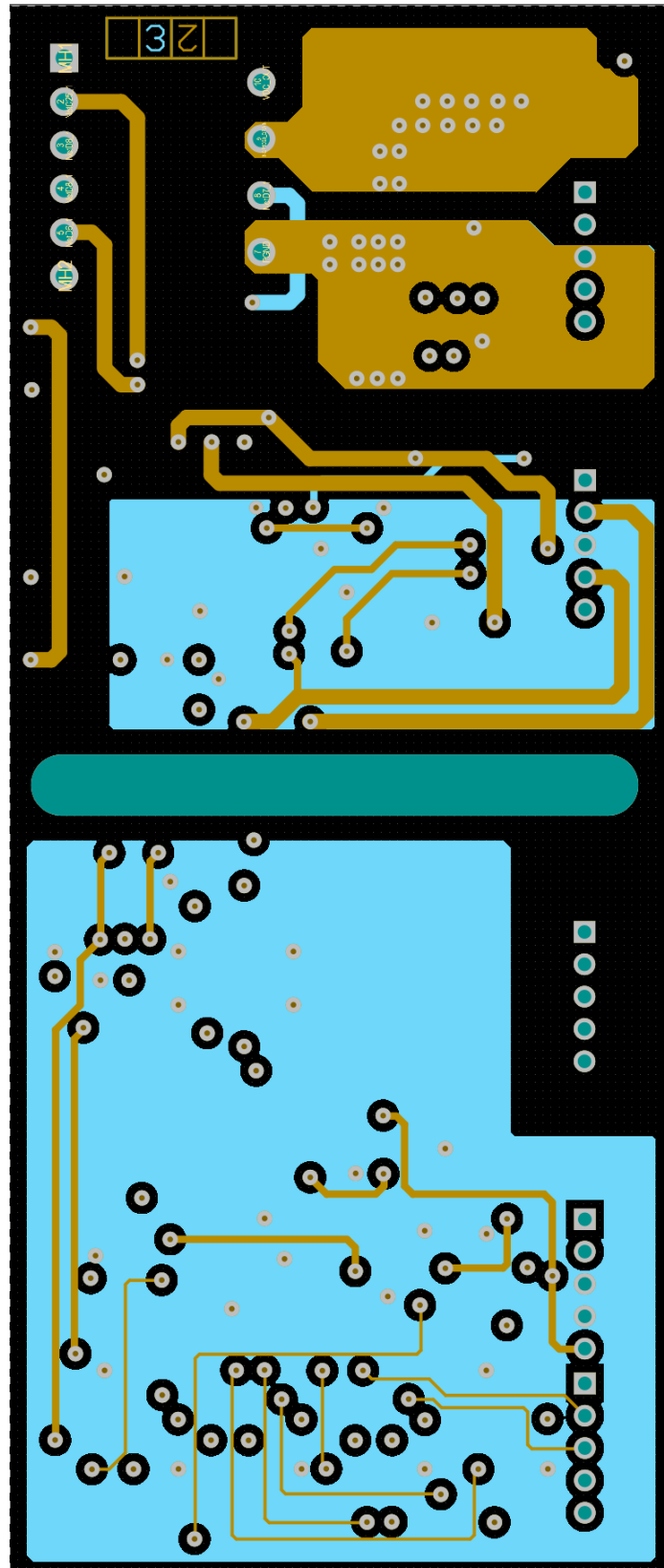

Fig. 13. Daughterboard PCB inner layers 2 (ground plane) and 3 (power and ground planes)

5.5. Mainboard Bill of Materials

Table 3. Mainboard Bill of Material

Part	Value	Voltage	Package	Description	Supplier	Supplier P/N
C1	100n	50V	C0603	Capacitor, Ceramic	RS	114-0367
C2	100n	50V	C0603	Capacitor, Ceramic	RS	114-0367
C3	100n	50V	C0603	Capacitor, Ceramic	RS	114-0367
C4	22u	25V	C0805	Capacitor, Ceramic	Farnell	1907510
C5	100n	50V	C0603	Capacitor, Ceramic	RS	114-0367
C6	22u	25V	C0805	Capacitor, Ceramic	Farnell	1907510
C7	100p	100V	C0603	Capacitor, Ceramic, C0G	Farnell	1740605
C8	100p	100V	C0603	Capacitor, Ceramic, C0G	Farnell	1740605
C9	-	-	C0805	Capacitor, Ceramic	-	-
C10	100n	50V	C0603	Capacitor, Ceramic	RS	114-0367
C11	100n	50V	C0603	Capacitor, Ceramic	RS	114-0367
C12	100n	50V	C0603	Capacitor, Ceramic	RS	114-0367
C13	10u	25V	C0805	Capacitor, Ceramic	Farnell	1735530
C14	100n	50V	C0603	Capacitor, Ceramic	RS	114-0367
C15	10u	25V	C0805	Capacitor, Ceramic	Farnell	1735530
C16	-	-	C0805	Capacitor, Ceramic	-	-
C18	10u	25V	C0805	Capacitor, Ceramic	Farnell	1735530
C19	10u	25V	C0805	Capacitor, Ceramic	Farnell	1735530
C20	100p	100V	C0603	Capacitor, Ceramic, C0G	Farnell	1740605
C21	100p	100V	C0603	Capacitor, Ceramic, C0G	Farnell	1740605
C22	10u	25V	C0805	Capacitor, Ceramic	Farnell	1735530
C23	10u	25V	C0805	Capacitor, Ceramic	Farnell	1735530
C26	1u	25V	C0603	Capacitor, Ceramic	Farnell	2346962
C27	22u	25V	C0805	Capacitor, Ceramic	Farnell	1907510
C28	22u	25V	C0805	Capacitor, Ceramic	Farnell	1907510
C29	22u	25V	C0805	Capacitor, Ceramic	Farnell	1907510
C30	22u	25V	C0805	Capacitor, Ceramic	Farnell	1907510
C32	-	-	C2220	Capacitor, Ceramic	-	-
C33	-	-	C2220	Capacitor, Ceramic	-	-
C34	680n	450V	C2220	Capacitor, Ceramic	Mouser	810-CGA9M4X7T2W864MA
C35	10n	1kV	C1206	Capacitor, Ceramic	Mouser	581-1206AC103KAT2A
C36	10n	1kV	C1206	Capacitor, Ceramic	Mouser	581-1206AC103KAT2A
C37	470u	450V	Radial	Capacitor, Electrolytic	Mouser	80-ALC10A471DF450
C38	470u	450V	Radial	Capacitor, Electrolytic	Mouser	80-ALC10A471DF450
C39	470u	450V	Radial	Capacitor, Electrolytic	Mouser	80-ALC10A471DF450
C40	470u	450V	Radial	Capacitor, Electrolytic	Mouser	80-ALC10A471DF450
C50	10n	1kV	C1206	Capacitor, Ceramic	Mouser	581-1206AC103KAT2A

4 kW analogue bridgeless totem-pole PFC evaluation board

Part	Value	Voltage	Package	Description	Supplier	Supplier P/N
C51	10n	1kV	C1206	Capacitor, Ceramic	Mouser	581-1206AC103KAT2A
C52	-	-	C1210	Capacitor, Ceramic	-	-
C53	-	-	C1210	Capacitor, Ceramic	-	-
C54	10n	1kV	C1206	Capacitor, Ceramic	Mouser	581-1206AC103KAT2A
CMC1				CMC 3.9mH 25A 2LN TH	DigiKey	2258-T60405R6128X225-ND
CMC2				CMC 3.9mH 25A 2LN TH	DigiKey	2258-T60405R6128X225-ND
CX1	1.5u	310V	Radial	Capacitor, PP Film	Mouser	710-890334026030CS
CX2	1.5u	310V	Radial	Capacitor, PP Film	Mouser	710-890334026030CS
CX3	1.5u	310V	Radial	Capacitor, PP Film	Mouser	710-890334026030CS
CY1	4.7n	630V	Radial	Capacitor, PP Film	DigiKey	BC1615-ND
CY2	4.7n	630V	Radial	Capacitor, PP Film	DigiKey	BC1615-ND
D1	PMEG 2020EJ	20V	SOD-323	Diode, Schottky	Nexperia	PMEG2020EJ
D2	ES1J	600V	DO-214AC	Diode	Farnell	3519291
D3	PMEG 6002EB	60V	SOD-523	Diode, Schottky	Nexperia	PMEG6002EB
D4	ES1J	600V	DO-214AC	Diode	Farnell	3519291
D5	-	-	DO-214AC	Diode	-	-
D6	-	-	DO-214AC	Diode	-	-
D11	GBJ2506-F	600V		Bridge Rectifier	Farnell	3127402
F1				Fuse Clip TH	Farnell	2762088
F1				Fuse	Farnell	1150557
FB11	30R		FB0603	Ferrite	Farnell	1515741
FB12	30R		FB0603	Ferrite	Farnell	1515741
FB13	30R		FB0603	Ferrite	Farnell	1515741
FB14	30R		FB0603	Ferrite	Farnell	1515741
J1				4-Pin Header TH	RS	144-8185
JP1				Jumper Link SMD	Farnell	2751488
JP2				Jumper Link SMD	Farnell	2751488
K1				Relay SPST-NO 30A	Farnell	2395974
L1	480uH				AGW	
L2	46.65uH				AGW	
LED1	LED		D0603	LED, Green	Farnell	8529833
LED2	LED		D0603	LED, Green	Farnell	8529833
LED3	LED		D0603	LED, Green	Farnell	8529833
LED4	LED		D0603	LED, Green	Farnell	8529833
LED6	LED		D0603	LED, Green	Farnell	8529833
LED7	LED		D0603	LED, Green	Farnell	8529833
LED8	LED		D0603	LED, Red	Farnell	2099224
Q1	GAN039 -650NTB	650V	CCPAK	GaN FET	Nexperia	GAN039-650NTB
Q2	GAN039 -650NTB	650V	CCPAK	GaN FET	Nexperia	GAN039-650NTB
Q3	GAN039 -650NTB	650V	CCPAK	GaN FET	Nexperia	GAN039-650NTB
Q4	GAN039 -650NTB	650V	CCPAK	GaN FET	Nexperia	GAN039-650NTB
Q5	-	-	TO-247	MOSFET	-	-

4 kW analogue bridgeless totem-pole PFC evaluation board

Part	Value	Voltage	Package	Description	Supplier	Supplier P/N
Q6	-	-	TO-247	MOSFET	-	-
R1	10R		R1206	Resistor	Farnell	1738986
R2	15R		R0805	Resistor	Farnell	2057671
R3	15R		R0805	Resistor	Farnell	2057671
R4	10R		R1206	Resistor	Farnell	1738986
R5	10R		R1206	Resistor	Farnell	1738986
R6	100R		R0805	Resistor	Farnell	1750741
R7	15R		R0603	Resistor	Farnell	2335857
R8	10R		R1206	Resistor	Farnell	1738986
R9	15R		R0805	Resistor	Farnell	2057671
R10	15R		R0603	Resistor	Farnell	2335857
R11	37.4k		R1206	Resistor	Farnell	2307665
R12	37.4k		R1206	Resistor	Farnell	2307665
R13	37.4k		R1206	Resistor	Farnell	2307665
R14	37.4k		R1206	Resistor	Farnell	2307665
R15	37.4k		R1206	Resistor	Farnell	2307665
R16	37.4k		R1206	Resistor	Farnell	2307665
R17	47R			Inrush current limiter	DigiKey	317-1220-ND
R18	47R			Inrush current limiter	DigiKey	317-1220-ND
R19	10R		R1206	Resistor	Farnell	1738986
R20	10R		R1206	Resistor	Farnell	1738986
R21	15R		R0603	Resistor	Farnell	2335857
R22	10k		R0603	Resistor	RS	566-890
R23	10k		R0603	Resistor	RS	566-890
R24	10k		R0603	Resistor	RS	566-890
R25	10k		R0603	Resistor	RS	566-890
R26	15R		R0603	Resistor	Farnell	2335857
R27	10k		R0603	Resistor	RS	566-890
R28	10k		R0603	Resistor	RS	566-890
R30	51k		R0603	Resistor	Farnell	2059471
R31	33k		R0603	Resistor	Farnell	2303204
R32	10k		R0603	Resistor	RS	566-890
R33	10k		R0603	Resistor	RS	566-890
R34	4.7k		R0603	Resistor	Farnell	2303181
R35	4.7k		R0603	Resistor	Farnell	2303181
R36	4.7k		R0603	Resistor	Farnell	2303181
R37	4.7k		R0603	Resistor	Farnell	2303181
R41	10R		R1206	Resistor	Farnell	1738986
R43	-		R0805	Resistor	-	-
R44	-		R0805	Resistor	-	-
R45	-		R0603	Resistor	-	-
R46	-		R0603	Resistor	-	-
R47	2k		R0603	Resistor	Farnell	2059343
R48	2k		R0603	Resistor	Farnell	2059343

4 kW analogue bridgeless totem-pole PFC evaluation board

Part	Value	Voltage	Package	Description	Supplier	Supplier P/N
R50	4m		R2512	Resistor	DigiKey	YAG6087CT-ND
R51	4m		R2512	Resistor	DigiKey	YAG6087CT-ND
R52	37.4k		R1206	Resistor	Farnell	2307665
R53	37.4k		R1206	Resistor	Farnell	2307665
R54	37.4k		R1206	Resistor	Farnell	2307665
R55	37.4k		R1206	Resistor	Farnell	2307665
R56	0R		R1206	Resistor	Farnell	2797493
R57	10R		R1206	Resistor	Farnell	1738986
U1	Si8273BBD -ISR1	2.5kV	SOIC16	ISO Hi/Lo gate driver	Mouser	634-SI8273BB-IS1R
U2	CAP-019		SOIC8	Cap discharge	DigiKey	596-1684-1-ND
U3	Si8273BBD -ISR1	2.5kV	SOIC16	ISO Hi/Lo gate driver	Mouser	634-SI8273BB-IS1R
X1		690V		3-pos terminal block	Farnell	3704713
X2				5 x MMS-105-01-L-SV	RS	180-4953
X3	-	-			-	-
X4	-	-			-	-
X5	-	-			-	-
X6	-	-			-	-
X7	-	-			-	-
X8	-	-			-	-
X10		690V		2-pos terminal block	Farnell	3704701
HS1				Heatsink/Fan assy	Fischer	LAM5 50 12
HS1				Housing – Fan assy	Farnell	2751642
HS1				Crimp – Fan assy	Farnell	2063734
HS1				Crimp – Fan assy	Farnell	2063734
HS1				Crimp – Fan assy	Farnell	2063734
HS1				Crimp – Fan assy	Farnell	2063734
HS1				Insulator 50mm sq	DigiKey	345-1548-ND
HS1				M3 x 2.5mm custom spacer		
HS1				M3 x 2.5mm custom spacer		
HS1				M3 x 2.5mm custom spacer		
HS1				M3 x 2.5mm custom spacer		
HS1				M3 x 5mm Square nut	RS	837-262
HS1				M3 x 5mm Square nut	RS	837-262
HS1				M3 x 5mm Square nut	RS	837-262
HS1				M3 x 5mm Square nut	RS	837-262
HS1				Custom holder Square nut		
HS1				Custom holder Square nut		
HS1				Custom holder Square nut		

4 kW analogue bridgeless totem-pole PFC evaluation board

Part	Value	Voltage	Package	Description	Supplier	Supplier P/N
HS1				Custom holder Square nut		
HS1				M3 x 12mm Pozi screw	Farnell	1420391
HS1				M3 x 12mm Pozi screw	Farnell	1420391
HS1				M3 x 12mm Pozi screw	Farnell	1420391
HS1				M3 x 12mm Pozi screw	Farnell	1420391
ST1				M3 x 15mm Standoff	Farnell	1336157
ST2				M3 x 15mm Standoff	Farnell	1336157
ST3				M3 x 15mm Standoff	Farnell	1336157
ST4				M3 x 15mm Standoff	Farnell	1336157
ST5				M3 x 15mm Standoff	Farnell	1336157
ST6				M3 x 15mm Standoff	Farnell	1336157
ST7				M3 x 15mm Standoff	Farnell	1336157
ST8				M3 x 15mm Standoff	Farnell	1336157
ST9				M3 x 15mm Standoff	Farnell	1336157
ST10				M3 x 15mm Standoff	Farnell	1336157
ST1				M3 x 6mm Pozi screw	Farnell	1419986
ST2				M3 x 6mm Pozi screw	Farnell	1419986
ST3				M3 x 6mm Pozi screw	Farnell	1419986
ST4				M3 x 6mm Pozi screw	Farnell	1419986
ST5				M3 x 6mm Pozi screw	Farnell	1419986
ST6				M3 x 6mm Pozi screw	Farnell	1419986
ST7				M3 x 6mm Pozi screw	Farnell	1419986
ST8				M3 x 6mm Pozi screw	Farnell	1419986
ST9				M3 x 6mm Pozi screw	Farnell	1419986
ST10				M3 x 6mm Pozi screw	Farnell	1419986
				PCB	PCBWay	

5.6. Daughterboard Bill of Materials

Table 4. Daughterboard Bill of Material

Part	Value	Voltage	Package	Description	Supplier	Supplier P/N
C1	1.5n	50V	C0603	Capacitor, Ceramic	Mouser	81-GRM1885C1H152JA01
C2	100p	100V	C0603	Capacitor, Ceramic, C0G	Mouser	581-06031C101K
C3	560n	10V	C0603	Capacitor, Ceramic	DigiKey	399-C0603C564K8PAC7867CT-ND
C4	4.7u	35V	C0603	Capacitor, Ceramic	Mouser	81-GRM188R6YA475KE5D
C5	100p	100V	C0603	Capacitor, Ceramic, C0G	Mouser	581-06031C101K
C6	100p	100V	C0603	Capacitor, Ceramic, C0G	Mouser	581-06031C101K
C7	22p	100V	C0603	Capacitor, Ceramic, C0G	Mouser	80-C0603C220J1G
C8	1n	50V	C0603	Capacitor, Ceramic	Mouser	603-CC603MRX7R9BB102
C9	100p	100V	C0603	Capacitor, Ceramic, C0G	Mouser	581-06031C101K
C10	22p	100V	C0603	Capacitor, Ceramic, C0G	Mouser	80-C0603C220J1G
C11	100p	100V	C0603	Capacitor, Ceramic, C0G	Mouser	581-06031C101K
C12	1n	50V	C0603	Capacitor, Ceramic	Mouser	603-CC603MRX7R9BB102
C13	100p	100V	C0603	Capacitor, Ceramic, C0G	Mouser	581-06031C101K
C14	1n	50V	C0603	Capacitor, Ceramic	Mouser	603-CC603MRX7R9BB102
C15	10u	25V	C0805	Capacitor, Ceramic	Mouser	81-GRM21BC71E106KE1L
C16	10u	25V	C0805	Capacitor, Ceramic	Mouser	81-GRM21BC71E106KE1L
C17	10u	25V	C0805	Capacitor, Ceramic	Mouser	81-GRM21BC71E106KE1L
C18	10u	25V	C0805	Capacitor, Ceramic	Mouser	81-GRM21BC71E106KE1L
C19	10u	25V	C0805	Capacitor, Ceramic	Mouser	81-GRM21BC71E106KE1L
C20	10u	25V	C0805	Capacitor, Ceramic	Mouser	81-GRM21BC71E106KE1L
C21	1u	25V	C0603	Capacitor, Ceramic	Mouser	187-CL10B105KA8NNNC
C22	1u	25V	C0603	Capacitor, Ceramic	Mouser	187-CL10B105KA8NNNC
C23	1u	25V	C0603	Capacitor, Ceramic	Mouser	187-CL10B105KA8NNNC
C24	1u	25V	C0603	Capacitor, Ceramic	Mouser	187-CL10B105KA8NNNC
C25	220u	16V	SMD	Capacitor, Polymer	Mouser	P124158CT-ND
C26	22u	25V	C1206	Capacitor, Ceramic	Mouser	810-C3216X5R1E226M
C27	22u	25V	C1206	Capacitor, Ceramic	Mouser	810-C3216X5R1E226M
C28	10n	25V	C0603	Capacitor, Ceramic	Mouser	603-CC603KRX7R8BB103
C29	10u	25V	C0805	Capacitor, Ceramic	Mouser	81-GRM21BC71E106KE1L
C30	10u	25V	C0805	Capacitor, Ceramic	Mouser	81-GRM21BC71E106KE1L
C31	10u	25V	C0805	Capacitor, Ceramic	Mouser	81-GRM21BC71E106KE1L
C32	10n	25V	C0603	Capacitor, Ceramic	Mouser	603-CC603KRX7R8BB103
C33	22n	25V	C0603	Capacitor, Ceramic	Mouser	603-CC603KRX7R8BB223

4 kW analogue bridgeless totem-pole PFC evaluation board

Part	Value	Voltage	Package	Description	Supplier	Supplier P/N
C34	10n	1kV	C1206	Capacitor, Ceramic	Mouser	581-1206AC103KAT2A
C35	10n	1kV	C1206	Capacitor, Ceramic	Mouser	581-1206AC103KAT2A
C36	1u	25V	C0603	Capacitor, Ceramic	Mouser	187-CL10B105KA8NNNC
C37	1n	50V	C0603	Capacitor, Ceramic	Mouser	603-CC603MRX7R9BB102
C38	10n	25V	C0603	Capacitor, Ceramic	Mouser	603-CC603KRX7R8BB103
C39	1u	25V	C0603	Capacitor, Ceramic	Mouser	187-CL10B105KA8NNNC
C40	1u	25V	C0603	Capacitor, Ceramic	Mouser	187-CL10B105KA8NNNC
C41	10u	25V	C0805	Capacitor, Ceramic	Mouser	81-GRM21BC71E106KE1L
C42	10u	25V	C0805	Capacitor, Ceramic	Mouser	81-GRM21BC71E106KE1L
C43	10u	25V	C0805	Capacitor, Ceramic	Mouser	81-GRM21BC71E106KE1L
C44	10u	25V	C0805	Capacitor, Ceramic	Mouser	81-GRM21BC71E106KE1L
C45	1u	25V	C0603	Capacitor, Ceramic	Mouser	187-CL10B105KA8NNNC
CMC1				CMC 100uH, 200mA, SMD	Mouser	810-ACT45R1012PTL001
CMC2				CMC 100uH, 200mA, SMD	Mouser	810-ACT45R1012PTL001
D1	PMEG3010EB	30V	SOD-523	Diode, Schottky	Nexperia	PMEG3010EB
D2	BAT54C	30V	SOT-23	Dual diode, Schottky	Nexperia	BAT54C, 215
D3	ES1J	600V	DO-214AC	Diode	Mouser	833-ES1J-LTP
D4	ES1J	600V	DO-214AC	Diode	Mouser	833-ES1J-LTP
D5	ES1J	600V	DO-214AC	Diode	Mouser	833-ES1J-LTP
D6	ES1J	600V	DO-214AC	Diode	Mouser	833-ES1J-LTP
D7	ES1J	600V	DO-214AC	Diode	Mouser	833-ES1J-LTP
D8	ES1J	600V	DO-214AC	Diode	Mouser	833-ES1J-LTP
D9	PMEG3010EB	30V	SOD-523	Diode, Schottky	Nexperia	PMEG3010EB
D10	PMEG3010EB	30V	SOD-523	Diode, Schottky	Nexperia	PMEG3010EB
D11	PMEG3010EB	30V	SOD-523	Diode, Schottky	Nexperia	PMEG3010EB
FB1	600R		FB0603	Ferrite	Mouser	810-MMZ1608B601CTAH0
L1	4.7uH			Inductor	Mouser	710-74438323047
Q1	BSH103BKR	30V	SOT-23	MOSFET n-chan	Nexperia	BSH103BKR
Q2	SSM3J334R	30V	SOT-23	MOSFET p-chan	Mouser	757-SSM3J334RLF
Q3	SSM3J334R	30V	SOT-23	MOSFET p-chan	Mouser	757-SSM3J334RLF
R1	330R		R0603	Resistor	Mouser	603-AC0603FR-07330RL
R2	33k		R0603	Resistor	Mouser	603-AC0603FR-0733KL
R3	2.61k		R0603	Resistor	Mouser	660-RK73H1JTDD2611F
R4	16k		R0603	Resistor	Mouser	660-RK73H1JTDD1602F
R5	3.57k		R0603	Resistor	Mouser	660-RK73H1JTDD3571F
R6	30k		R0603	Resistor	Mouser	603-AC0603FR-0730KL
R7	1M		R0603	Resistor	Mouser	603-RC0603FR-131ML
R8	5.1k		R0603	Resistor	Mouser	603-AC0603FR-075K1L
R9	470k		R1206	Resistor	Mouser	660-RK73H2BTDD4703F
R10	470k		R1206	Resistor	Mouser	660-RK73H2BTDD4703F
R11	470k		R1206	Resistor	Mouser	660-RK73H2BTDD4703F
R12	470k		R1206	Resistor	Mouser	660-RK73H2BTDD4703F

4 kW analogue bridgeless totem-pole PFC evaluation board

Part	Value	Voltage	Package	Description	Supplier	Supplier P/N
R13	470k		R1206	Resistor	Mouser	660-RK73H2BTTD4703F
R14	470k		R1206	Resistor	Mouser	660-RK73H2BTTD4703F
R15	1.8k		R0603	Resistor	Mouser	279-CRGCQ0603F1K8
R16	61.9k		R0603	Resistor	Mouser	660-RK73H1JTDD6192F
R17	470k		R1206	Resistor	Mouser	660-RK73H2BTTD4703F
R18	470k		R1206	Resistor	Mouser	660-RK73H2BTTD4703F
R19	470k		R1206	Resistor	Mouser	660-RK73H2BTTD4703F
R20	100k		R0603	Resistor	Mouser	660-RK73H1JTDD1003F
R21	1k		R0603	Resistor	DigiKey	RMCF0603FT1K00CT-ND
R22	1M		R0603	Resistor	Mouser	603-RC0603FR-131ML
R23	5.1k		R0603	Resistor	Mouser	603-AC0603FR-075K1L
R24	30k		R0603	Resistor	Mouser	603-AC0603FR-0730KL
R25	40.2k		R0603	Resistor	Mouser	660-RK73H1JTDD4022F
R26	10k		R0603	Resistor	Mouser	603-AC0603FR-0710KL
R27	1.21k		R0603	Resistor	Mouser	660-RK73H1JTDD1211F
R28	470k		R1206	Resistor	Mouser	660-RK73H2BTTD4703F
R29	470k		R1206	Resistor	Mouser	660-RK73H2BTTD4703F
R30	470k		R1206	Resistor	Mouser	660-RK73H2BTTD4703F
R33	470k		R1206	Resistor	Mouser	660-RK73H2BTTD4703F
R34	470k		R1206	Resistor	Mouser	660-RK73H2BTTD4703F
R35	470k		R1206	Resistor	Mouser	660-RK73H2BTTD4703F
R36	49.9R		R0603	Resistor	Mouser	660-RK73H1JTDD49R9F
R37	100k		R0603	Resistor	Mouser	660-RK73H1JTDD1003F
R39	39.2k		R0603	Resistor	Mouser	660-RK73H1JTDD3922F
R40	49.9R		R0603	Resistor	Mouser	660-RK73H1JTDD49R9F
R41	20k		R0603	Resistor	Mouser	660-RK73H1JTDD2002F
R42	10k		R0603	Resistor	Mouser	603-AC0603FR-0710KL
R43	470R		R0603	Resistor	Mouser	652-CR0603FX-4700ELF
R44	10k		R0603	Resistor	Mouser	603-AC0603FR-0710KL
R45	22.1k		R0603	Resistor	Mouser	660-RK73H1JTDD2212F
R46	48.7k		R0603	Resistor	Mouser	660-RK73H1JTDD4872F
R47	220k		R0603	Resistor	Mouser	660-RK73H1JTDD2203F
R48	12.1k		R0603	Resistor	Mouser	660-RK73H1JTDD1212F
R49	0R		R0603	Resistor	Mouser	603-RC0603FR-070RL
R50	49.9k		R0603	Resistor	Mouser	660-RK73H1JTDD4992F
R51	10k		R0603	Resistor	Mouser	603-AC0603FR-0710KL
R52	1M		R0603	Resistor	Mouser	603-RC0603FR-131ML
R53	24.9k		R0603	Resistor	Mouser	660-RK73H1JTDD2492F
R54	1k		R0603	Resistor	DigiKey	RMCF0603FT1K00CT-ND
R55	61.9k		R0603	Resistor	Mouser	660-RK73H1JTDD6192F
R56	48.7k		R0603	Resistor	Mouser	660-RK73H1JTDD4872F
R57	124k		R0603	Resistor	Mouser	660-RK73H1JTDD1243F
R58	12.1k		R0603	Resistor	Mouser	660-RK73H1JTDD1212F
R59	49.9k		R0603	Resistor	Mouser	660-RK73H1JTDD4992F

4 kW analogue bridgeless totem-pole PFC evaluation board

Part	Value	Voltage	Package	Description	Supplier	Supplier P/N
R60	1M		R0603	Resistor	Mouser	603-RC0603FR-131ML
R61	24.9k		R0603	Resistor	Mouser	660-RK73H1JTDD2492F
R62	1k		R0603	Resistor	DigiKey	RMCF0603FT1K00CT-ND
R63	24.9k		R0603	Resistor	Mouser	660-RK73H1JTDD2492F
R64	39.2k		R0603	Resistor	Mouser	660-RK73H1JTDD3922F
R65	12.1k		R0603	Resistor	Mouser	660-RK73H1JTDD1212F
T1				Flyback Transformer, TH	Würth	750314352
U1			SOIC8	Power Factor Controller	Mouser	595-UCC28180DR
U2			SOIC8	Comparator	Mouser	511-TS393IDT
U3			SOIC8	Op-amp	Mouser	511-TSX712IDT
U4			SOT-23-6	Comparator with shutdown	Mouser	926-LMV761MF
U5	74LV32APW		TSSOP-14	Quad 2-input OR gate	Nexperia	74LV32APW
U6	74LV04PW		TSSOP-14	Hex NOT gate	Nexperia	74LV04PW
U7	74LV08PW		TSSOP-14	Quad 2-input AND gate	Nexperia	74LV08PW
U8	74LV08PW		TSSOP-14	Quad 2-input AND gate	Nexperia	74LV08PW
U9			Mini-flat	Opto-coupler	Mouser	512-FODM8801A
U10			SOT-23	Vref adjustable	Mouser	NCP432BISNT1G0SCT-ND
U11			SOIC16	Offline switcher	Mouser	863-NCP1063AD060R2G
U12			SOIC8	Comparator	Mouser	511-TS393IDT
U13			SOT-23-5	Regulator LDO adjustable	Mouser	497-16672-1-ND
U14			SOT-23-5	Regulator LDO adjustable	Mouser	497-16672-1-ND
X1				TMM-105-01-L-S-RA	Mouser	200-TMM10501LSRA
X2				TMM-105-01-L-S-RA	Mouser	200-TMM10501LSRA
X3				TMM-105-01-L-S-RA	Mouser	200-TMM10501LSRA
X4				TMM-105-01-L-S-RA	Mouser	200-TMM10501LSRA
X5				TMM-105-01-L-S-RA	Mouser	200-TMM10501LSRA
Z1	BZX585-B4V7	4.7V	SOD-523	Diode, Zener	Nexperia	BZX585-B4V7
Z2		170V	DO-214AC	Diode, TVS unidirectional	Mouser	625-SMAJ170A-E3
Z3		16V	DO-214AC	Diode, Zener	Mouser	621-SMAZ16-13-F
				PCB	PCBWay	

6. Using the board

The board can be used for evaluation of Nexperia GAN039-650NTB GaN FETs in a bridgeless totem-pole PFC circuit. It is not a complete circuit, but rather a building block.

6.1. Turn on sequence

1. Insert the daughterboard into the corresponding connectors on the mainboard marked X2 on the PCB, making sure that all pins are aligned correctly and inserted fully.
2. Connect an electronic/resistive load to the output terminal block marked X10 on the PCB, making sure that the correct polarity is observed (if applicable).
The requirements for the resistive load are:
 - at 115 VAC input: between 0 W and ≤ 2000 W
 - at 230 VAC input: between 0 W and ≤ 4000 W
3. With the high voltage power OFF, connect the high-voltage AC power input to the input terminal block marked X1 on the PCB; L and N (PE: Protective Earth).
4. Turn ON the AC power input (85 VAC to 265 VAC, 50 Hz to 60 Hz):
 - minimum load power for turn-on sequence is 360 W
 - monitor X10 output voltage with a VDC meter and verify 385 V \pm 5 V is generated
 - load can be increased/decreased when AC supply is ON and board is functional

6.2. Turn off sequence

1. Turn OFF the high-voltage AC power input.
2. Verify input and output voltages are at 0 V.

7. Operational waveforms

[Fig. 14](#) shows the converter start-up procedure with an AC input voltage of 230V and an output load of 360W: CH1 shows the PWM applied to the gate of low-side GaN FET Q2, CH2 is the DC bus voltage waveform, CH3 is the voltage waveform of fast leg switching node (SW_NODE) and CH4 is the AC input current.

For the start-up, there are three phases to charge the DC bus to a reference voltage. Initially, the relay K1 contacts are open and the DC bus capacitors are charged by the input voltage through the inrush current limiters R17/R18 and the diode bridge D11. The inrush current limiters R17/R18 and diode bridge are applied in this circuit to avoid high inrush current flow through the GaN FETs.

When the voltage on VDC_OUT is over 100 V, the relay K1 contacts are closed to bypass the inrush current limiters, and the voltage on VDC_OUT increases to the peak of the input voltage. After approximately 100 ms following application of the AC input, the GaN FETs are engaged in closed-loop voltage control, in which the voltage on VDC_OUT slowly increases to the rated voltage of 385 V.

[Fig. 15](#) below shows the V_{DS} of Q2 during one turn-on event of a five pulse, single-shot staircase test at 50 kHz. The inductor is connected to the BUS voltage set at 400 V and the current flows through the low-side GaN FET and recirculates through the high-side GaN FET. Each pulse has a width of 3.8 μ s, leading to a peak inductor current of 36 A. It can be seen that the voltage spike is 19 V at $I_L = 22$ A.

The transient signal seen on V_{GS} when V_{DS} makes its low-to-high transition may appear to be an example of Miller feedback. Because of the extremely low Miller capacitance of the casacode switch, this is not actually the case. The voltage transient is due to di/dt in the small, but non-zero, source inductance. The internal V_{GS} actually changes very little during the transient, and there is therefore no concern for false turn-on.





Fig. 15. Waveforms of V_{GS} and V_{DS} of Q2 at I_L = 22 A

8. Dead-time control

The required form of the gate-drive signals is shown in [Fig. 16](#). The times marked A are the dead-times when neither GaN FET is driven on. The dead-time must be greater than zero to avoid shoot-through currents. The dead-times are set by resistors R3 and R5 on the daughterboard – the values specified in the Bill of Materials correspond to approximately 200 ns.

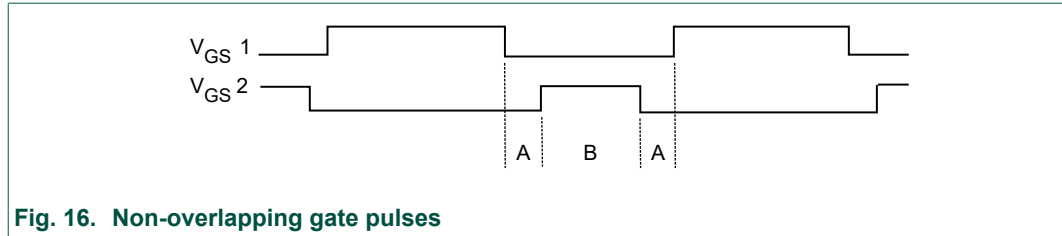

Fig. 16. Non-overlapping gate pulses

Nexperia GaN FETs can switch at dV/dt of 50 V/ns or higher to enable the lowest possible switching loss. At this level of operation, even the layout becomes a significant contributor to performance. As shown in [Fig. 8](#), the recommended PCB layout keeps a minimum gate drive loop; it also keeps the traces between the switching nodes very short, with the shortest practical return trace to the power bus and ground. The power ground plane provides a large cross-sectional area to achieve an even ground potential throughout the circuit.

For further information, the different layers of the Nexperia Analogue Totem-Pole PFC evaluation board design are shown in [Section 5.2](#).

9. Probing

As shown in Fig. 17 below, there are probing positions to allow measurement of V_{GS} Fig. 17 (a) and V_{DS} Fig. 17 (b) of the low-side fast switching GaN FET.

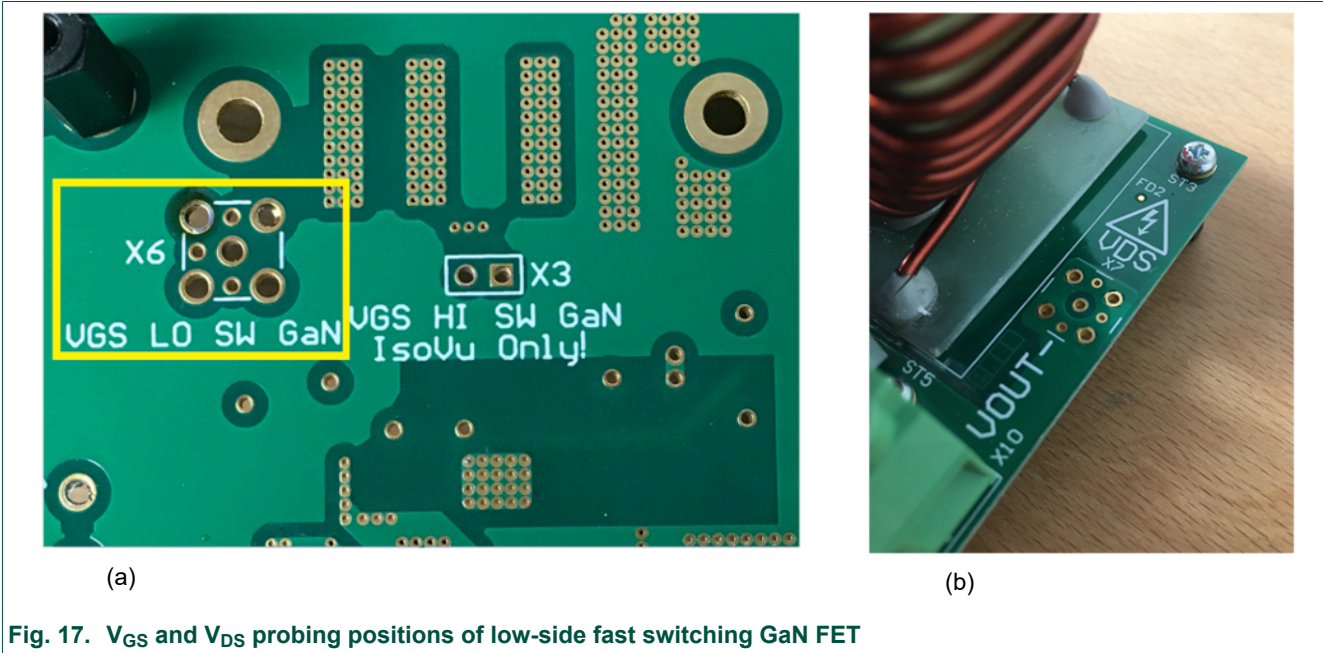

Fig. 17. V_{GS} and V_{DS} probing positions of low-side fast switching GaN FET

As shown in Fig. 18 below, there is also a probing position to allow measurement of V_{GS} of the low-side slow switching GaN FET.

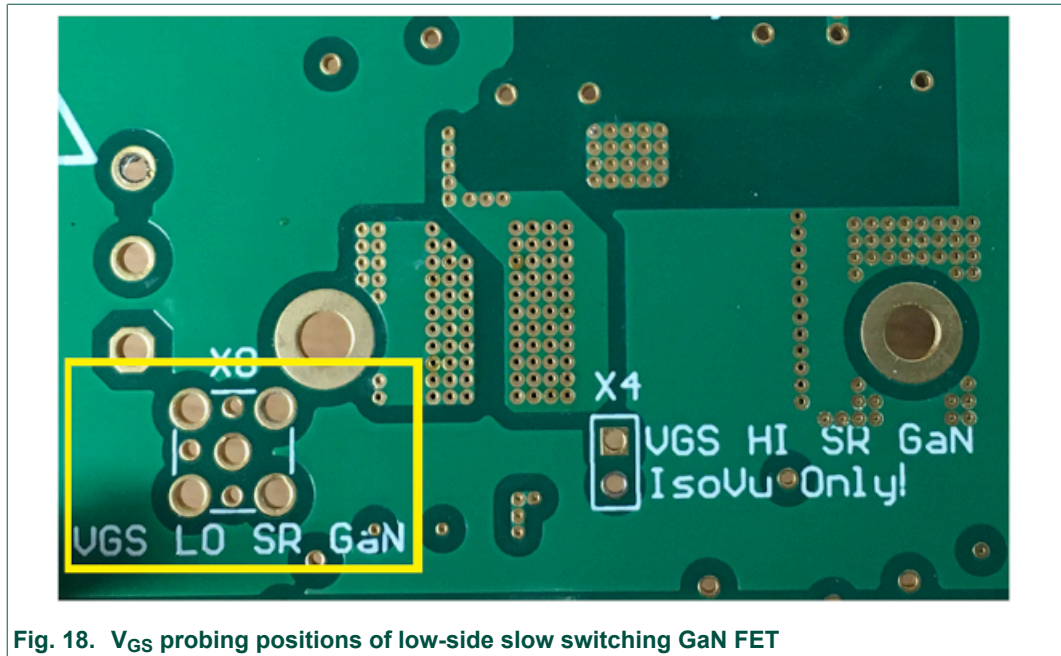

Fig. 18. V_{GS} probing positions of low-side slow switching GaN FET

4 kW analogue bridgeless totem-pole PFC evaluation board

As shown in [Fig. 19](#) below, there are also probing positions to allow measurement of high-side V_{GS} of both the fast switching and slow switching GaN FETs. For these signals to be measured during operation, it is recommended that optical probes, such as Tektronix IsoVu, are utilised.

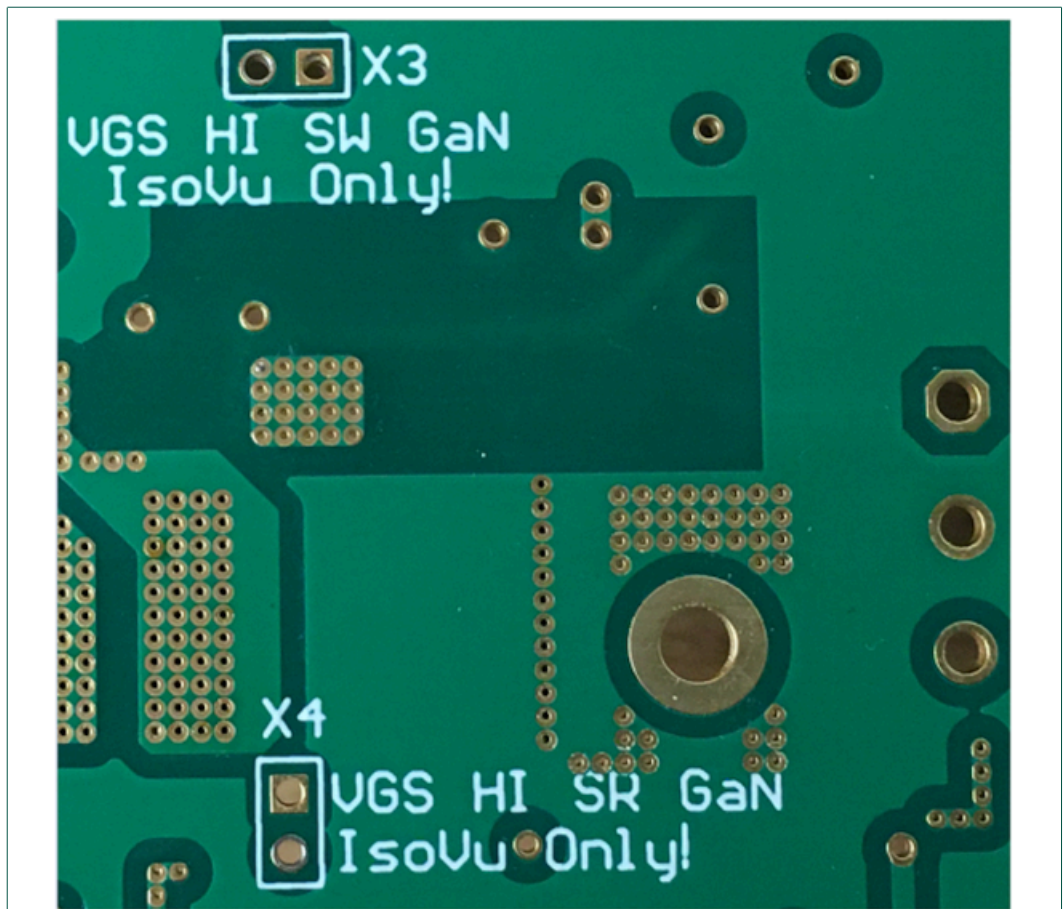

Fig. 19. V_{GS} probing positions of high-side fast and slow switching GaN FET

By removing the jumpers shown in [Fig. 20](#) below and using a short loop of thick gauge wire for the current probe to be clamped around, the PFC inductor current can also be measured.

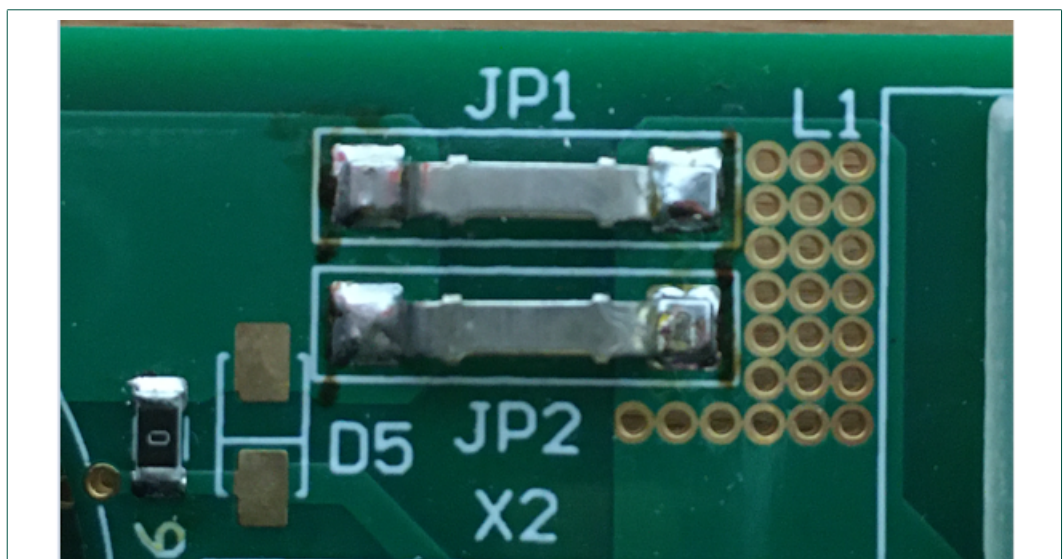

Fig. 20. Jumpers to be removed when measuring the inductor current

10. Efficiency sweeps

For the efficiency calculations, the input/output voltages and currents are measured using a power analyzer to obtain the input/output power values. Efficiency has been measured with either 115 VAC or 230 VAC input and 385 VDC output using a calibrated PPA5530 precision power analyzer from Newtons 4th. The efficiency results for the totem-Pole PFC board are shown in [Fig. 21](#).

The extremely high efficiency of > 98.8% at 230 VAC input and > 97.6% at 115 VAC input will enable customers to reach peak system efficiency to meet and exceed Titanium standards.

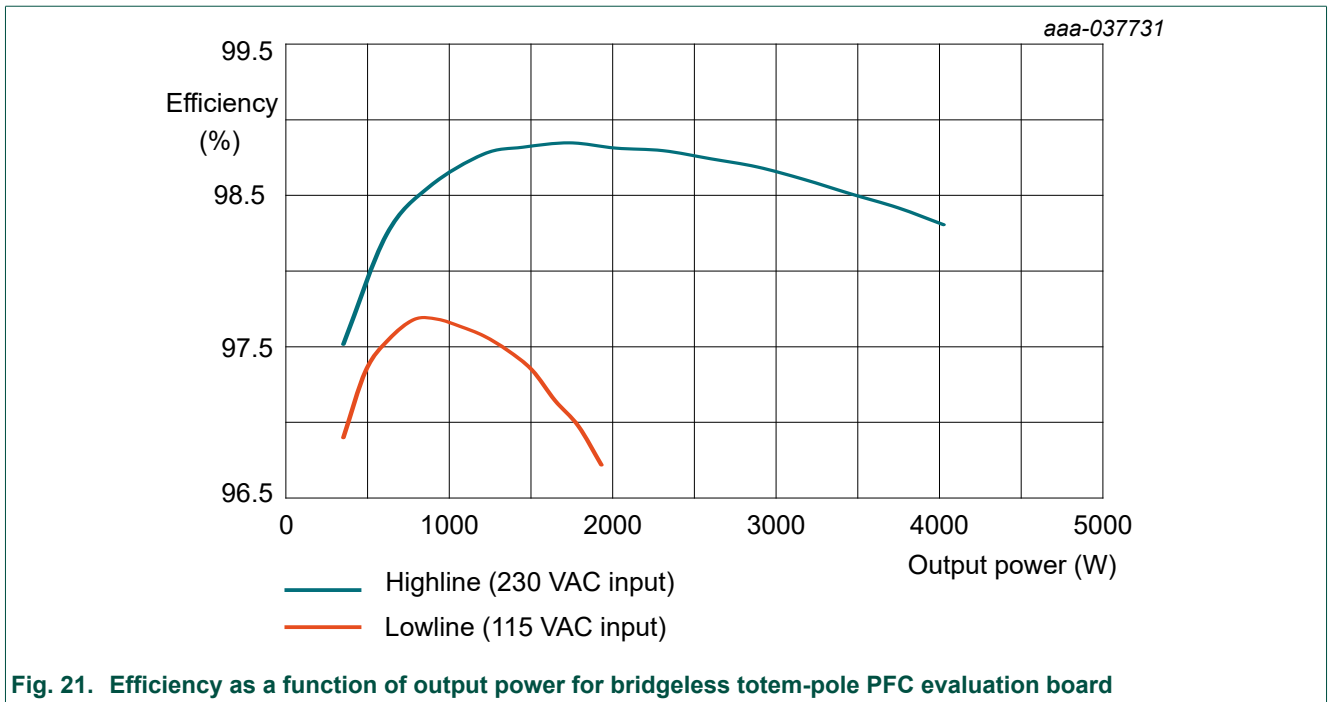

Fig. 21. Efficiency as a function of output power for bridgeless totem-pole PFC evaluation board

11. Revision history

Table 5. Revision history

Revision number	Date	Description
1.0	2023-11-21	Initial version.

12. Legal information

Definitions

Draft — The document is a draft version only. The content is still under internal review and subject to formal approval, which may result in modifications or additions. Nexperia does not give any representations or warranties as to the accuracy or completeness of information included herein and shall have no liability for the consequences of use of such information.

Disclaimers

Limited warranty and liability — Information in this document is believed to be accurate and reliable. However, Nexperia does not give any representations or warranties, expressed or implied, as to the accuracy or completeness of such information and shall have no liability for the consequences of use of such information. Nexperia takes no responsibility for the content in this document if provided by an information source outside of Nexperia.

In no event shall Nexperia be liable for any indirect, incidental, punitive, special or consequential damages (including - without limitation - lost profits, lost savings, business interruption, costs related to the removal or replacement of any products or rework charges) whether or not such damages are based on tort (including negligence), warranty, breach of contract or any other legal theory.

Notwithstanding any damages that customer might incur for any reason whatsoever, Nexperia's aggregate and cumulative liability towards customer for the products described herein shall be limited in accordance with the Terms and conditions of commercial sale of Nexperia.

Right to make changes — Nexperia reserves the right to make changes to information published in this document, including without limitation specifications and product descriptions, at any time and without notice. This document supersedes and replaces all information supplied prior to the publication hereof.

Suitability for use — Nexperia products are not designed, authorized or warranted to be suitable for use in life support, life-critical or safety-critical systems or equipment, nor in applications where failure or malfunction of an Nexperia product can reasonably be expected to result in personal injury, death or severe property or environmental damage. Nexperia and its suppliers accept no liability for inclusion and/or use of Nexperia products in such equipment or applications and therefore such inclusion and/or use is at the customer's own risk.

Applications — Applications that are described herein for any of these products are for illustrative purposes only. Nexperia makes no representation or warranty that such applications will be suitable for the specified use without further testing or modification.

Customers are responsible for the design and operation of their applications and products using Nexperia products, and Nexperia accepts no liability for any assistance with applications or customer product design. It is customer's sole responsibility to determine whether the Nexperia product is suitable and fit for the customer's applications and products planned, as well as for the planned application and use of customer's third party customer(s). Customers should provide appropriate design and operating safeguards to minimize the risks associated with their applications and products.

Nexperia does not accept any liability related to any default, damage, costs or problem which is based on any weakness or default in the customer's applications or products, or the application or use by customer's third party customer(s). Customer is responsible for doing all necessary testing for the customer's applications and products using Nexperia products in order to avoid a default of the applications and the products or of the application or use by customer's third party customer(s). Nexperia does not accept any liability in this respect.

Export control — This document as well as the item(s) described herein may be subject to export control regulations. Export might require a prior authorization from competent authorities.

Translations — A non-English (translated) version of a document is for reference only. The English version shall prevail in case of any discrepancy between the translated and English versions.

Trademarks

Notice: All referenced brands, product names, service names and trademarks are the property of their respective owners.

List of Tables

Table 1. 4 kW Analogue Totem-pole PFC evaluation board Input/Output specifications.....5

Table 2. GaN FET and equivalent CoolMOS MOSFET key parameter comparison..... 6

Table 3. Mainboard Bill of Material..... 21

Table 4. Daughterboard Bill of Material.....26

Table 5. Revision history.....36

List of Figures

Fig. 1. Example of a safety enclosure in the Nexperia lab...	2
Fig. 2. Example of a probe positioner.....	3
Fig. 3. 4 kW analogue totem-pole PFC evaluation board; top view with control card and heatsink fitted.....	4
Fig. 4. 4 kW analogue totem-pole PFC evaluation board; top view of GaN FETs (heatsink removed).....	4
Fig. 5. Totem-pole bridgeless PFC converter based on GaN FET.....	6
Fig. 6. GaN FET totem-pole bridgeless PFC converter.....	7
Fig. 7. Hard-switched waveform of a pair of GaN FET switches.....	8
Fig. 8. Mainboard PCB top layer.....	12
Fig. 9. Mainboard PCB bottom layer.....	13
Fig. 10. Mainboard PCB inner layers 2 (ground plane) and 3 (power and ground planes).....	14
Fig. 11. Daughterboard PCB top layer.....	18
Fig. 12. Daughterboard PCB bottom layer.....	19
Fig. 13. Daughterboard PCB inner layers 2 (ground plane) and 3 (power and ground planes).....	20
Fig. 14. Start-up of the bridgeless totem-pole PFC with 360 W load.....	31
Fig. 15. Waveforms of VGS and VDS of Q2 at IL = 22 A...	32
Fig. 16. Non-overlapping gate pulses.....	33
Fig. 17. VGS and VDS probing positions of low-side fast switching GaN FET.....	34
Fig. 18. VGS probing positions of low-side slow switching GaN FET.....	34
Fig. 19. VGS probing positions of high-side fast and slow switching GaN FET.....	35
Fig. 20. Jumpers to be removed when measuring the inductor current.....	35
Fig. 21. Efficiency as a function of output power for bridgeless totem-pole PFC evaluation board.....	36

Contents

1. EVALUATION BOARD TERMS OF USE.....	2
2. High Voltage Safety Precautions.....	2
3. Introduction.....	4
3.1. Warnings.....	5
3.2. Quick reference information.....	5
4. Circuit description.....	6
5. Design details.....	9
5.1. Mainboard schematics.....	10
5.2. Mainboard PCB layout.....	12
5.3. Daughterboard schematics.....	15
5.4. Daughterboard PCB Layout.....	18
5.5. Mainboard Bill of Materials.....	21
5.6. Daughterboard Bill of Materials.....	26
6. Using the board.....	30
6.1. Turn on sequence.....	30
6.2. Turn off sequence.....	30
7. Operational waveforms.....	30
8. Dead-time control.....	33
9. Probing.....	34
10. Efficiency sweeps.....	36
11. Revision history.....	36
12. Legal information.....	37

© Nexperia B.V. 2023. All rights reserved

For more information, please visit: <http://www.nexperia.com>

For sales office addresses, please send an email to: salesaddresses@nexperia.com

Date of release: 21 November 2023
